

# BENCHTOP ROBOT SOFTWARE USER GUIDE *Version H 1.33*

## Table of Contents

<b>SECTION 1: INTRODUCTION .....</b>	<b>5</b>
1.1 Introduction .....	6
1.2 Safety .....	6
1.3 New Features .....	6
1.4 Get Started .....	7
<b>SECTION 2: TOUR OF TEACH PENDANT .....</b>	<b>9</b>
2.1 Teach Pendant Overview .....	10
2.2 Operation .....	10
2.3 Key Introduction .....	11
2.4 Navigation Menu .....	12
2.5 Jogging .....	12
2.6 Data Entry .....	12
2.7 Running a Program .....	12
2.8 Teach Pendant Key Assignments .....	13
<b>SECTION 3: MENU INTRODUCTION .....</b>	<b>16</b>
3.1 F1 Menu .....	17
3.2 F2 Menu .....	21
3.2.1 Utility Menu .....	22
3.3 F3 Menu .....	23
3.4 F4 Menu .....	24
<b>SECTION 4: PROGRAMMING .....</b>	<b>27</b>
4.1 Programming Example .....	28
4.2 Good Programming Practices .....	32
4.3 Editing a Program .....	33
4.3.1 Changing a Point's XYZ location .....	33
4.3.2 Insert / Delete an Instruction .....	34
4.4 Changing the Program Number .....	35
4.5 Changing from Teach Mode to Run Mode .....	35
<b>SECTION 5: FUNCTION REFERENCE .....</b>	<b>36</b>
5.1 F1 Menu (Enter or F1 Key) .....	37
5.1.1 Dispense Dot .....	37
5.1.2 Line Start .....	37
5.1.3 Line Passing .....	38
5.1.4 Circle .....	38
5.1.5 Arc Point .....	39
5.1.6 Line End .....	39
5.1.7 End Program .....	39
5.1.8 Dispense ON / OFF .....	40
5.1.9 GOTO Address .....	41
5.1.10 Step & Repeat X .....	41
5.1.11 Step & Repeat Y .....	46
5.1.12 Brush Area .....	47
5.1.12.1 Brush Area: Rectangle .....	48
5.1.12.2 Brush Area: Circle .....	49
5.1.12.3 Brush Area: Rectangle 1 .....	50
5.1.12.4 Brush Area: Rect. Band .....	51
5.1.12.5 Brush Area: Circle Band .....	52
5.1.12.6 Brush Area: Circle 1 .....	53
5.1.12.7 Call Subroutine .....	54
5.1.13 Call Program .....	55
5.1.14 Set I/O .....	55
5.1.15 Wait Point .....	56
5.1.16 Stop Point .....	56
5.1.17 Home Point .....	56
5.1.18 Loop Address .....	56
5.1.19 Dummy Point .....	57
5.1.20 Initialize .....	57
5.1.21 Label .....	57
5.1.22 Display Counter .....	57

5.1.23	Loop Counter .....	57
5.1.24	Needle Adjustment .....	58
5.1.25	Needle Adjustment Counter .....	58
5.1.26	Arc Dispense Setup .....	59
5.2	F2 Menu (F2 Key).....	60
5.2.1	Group Edit .....	60
5.2.1.1	Copy.....	60
5.2.1.2	Delete.....	61
5.2.1.3	Move .....	62
5.2.1.4	Line SP (Line Speed).....	63
5.2.1.5	Dispense Time.....	64
5.2.1.6	Offset.....	65
5.2.1.7	Offset (R.E) .....	66
5.2.2	Expand Step & Repeat .....	67
5.2.3	Program Name.....	68
5.2.4	Z-axis Limit (mm) .....	68
5.2.5	Initial Output Port .....	68
5.2.6	Utility Menu.....	69
5.2.6.1	Program.....	69
5.2.6.2	Memory.....	69
5.2.6.3	Teach Pendant .....	70
5.2.6.4	Relocate Data .....	70
5.2.6.5	Lock or Unlock Program .....	72
5.2.6.6	Password Setup.....	72
5.2.6.7	Key Beep .....	72
5.2.6.8	Test Function .....	72
5.2.6.9	Clear Teach Pendant Data .....	72
5.3	F3 Menu (F3 Key).....	73
5.3.1	Numerical Move.....	73
5.3.2	Save Temp Point .....	73
5.3.3	Move To Temp Point.....	73
5.3.4	Undo Program.....	73
5.3.5	Redo Program.....	73
5.3.6	Debug Program .....	74
5.3.7	Move To Home Position .....	74
5.3.8	System Information .....	74
5.3.9	Execute Point.....	74
5.3.10	Program Name List.....	74
5.4	F4 Menu (F4 Key).....	75
5.4.1	Line Speed.....	75
5.4.2	Line Dispense Setup.....	75
5.4.3	Point Dispense Setup .....	76
5.4.4	Dispense End Setup .....	76
5.4.5	Z Clearance .....	78
5.4.6	X/Y Move Speed .....	79
5.4.7	Z Move Speed.....	79
5.4.8	Home Position Setup.....	80
5.4.9	Adjust Position Setup.....	81
5.4.10	Retract Setup.....	83
5.4.11	Quickstep .....	85
5.4.12	Auto Purge Setup .....	86
5.4.13	ESTOP Output Status.....	86
5.4.14	Acceleration.....	87
5.4.15	Pause Status.....	87
5.4.16	Language .....	87
5.4.17	Jog Speed.....	87
5.4.18	Debug Speed.....	87
5.4.19	Adjust Origin .....	88
5.4.20	Quickstep Path.....	88
5.4.21	USB Up/Down Load .....	88
5.4.22	Circle Delay Time.....	90
5.4.23	Initialize Setup .....	90
5.4.24	Teach Needle Adjustment.....	91
5.4.25	Teach Needle Adjustment Setup.....	92

## **SECTION 6: SAMPLE PROGRAMS.....94**

6.1	Dots, Lines and Arcs.....	95
6.2	Brush Area .....	97
6.3	Step & Repeat .....	98
6.4	Input / Output Signal Processing.....	100
6.5	Needle Calibration.....	102

**SECTION 7: SOFTWARE UPGRADE .....103**

7.1 *Check System Version*.....104  
7.2 *Upgrade Software*.....104

**SECTION 8: ERROR MESSAGES .....105**

8.1 *Point Closed Error* .....106  
8.1.1 *Need Line Start Point*.....106  
8.1.2 *Need Step & Repeat* .....106  
8.1.3 *Unlock Program* .....106  
8.1.4 *Address Over Memory* .....107  
8.1.5 *Move Over Memory* .....107  
8.1.6 *System Error* .....107  
8.1.7 *Over Speed Error*.....107

**SECTION 9: EQUIPMENT WARRANTY.....108**

9.1 *Equipment Warranty*.....109

# SECTION 1: Introduction

---

## **1.1 Introduction**

---

Welcome to the Henkel Benchtop Robots Software User Guide, this manual is an instructional guide designed for system operators, programmers, and process engineers. It provides a complete tour of the Robot control software with detailed explanations of all features.

In most cases, the software should arrive already installed and configured for your robot. If you should need to reinstall the software or upgrade to latest version, Please refer to **Section 7 – Software Upgrade**.

---

## **1.2 Safety**

---

Please review the Safety section in the applicable robot system manual before attempting to operate the robot system using procedures described in this manual.

---

## **1.3 New Features**

---

Below are listing some of latest features which support by **H 1.33** version.

- Upload and Download program via USB memory stick.
- Auto Needle calibration.
- Needle calibration counter
- Option for precise or fast needle calibration method.
- Arc dispense time control for pre-shut off

## 1.4 Get Started

A program consists of a series of instructions stored in the main memory unit. Each instruction is stored in a numbered memory address. A memory address may record a point location with an X, Y, and Z-axis value and point type or it may store an instruction, which sets a parameter, such as a dispensing time or line speed.

When the program is executed, the robot will go through each memory address in sequence and execute the instruction found there. If the memory address contains a point location, the robot will move the X, Y, and Z axes to that location. Depending on the type of point registered at that location, the robot may also perform other functions, such as turn the dispenser on or off.

The most commonly used point types are Dispense Dot, Line Start, Line Passing, Arc Point, and Line End.

To program the robot to dispense a 'dot' of material, the dispensing tip must be jogged to the desired XYZ location, then that location is registered as a DISPENSE DOT point type by pressing the appropriate keys on the Teach Pendant.



To program the robot to dispense a bead of material along a linear path, the XYZ location of the start of the line is registered as a LINE START point type. The locations where the tip changes direction are registered as LINE PASSING points. The end of the line is registered as a LINE END point:

The LINE START has already included DISPENSE ON function and the LINE END has already included DISPENSE OFF function.

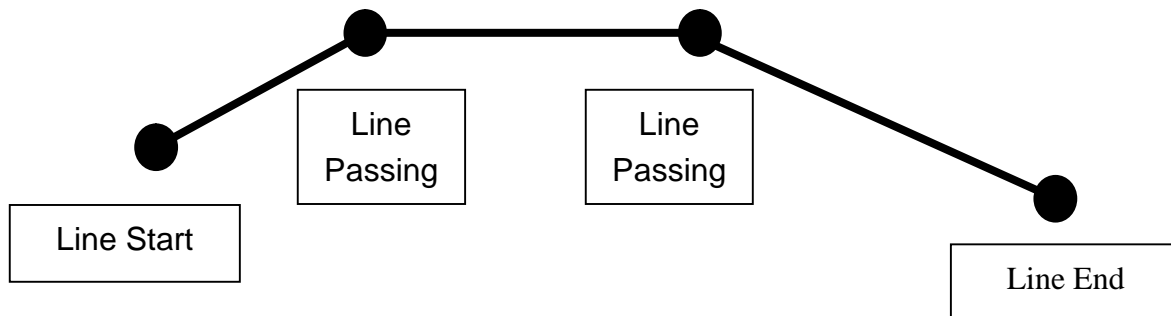

To dispense a bead of material in an arc, the XYZ location of the start of the line is registered as a LINE START point type. The high point of the arc is registered as an ARC POINT. The end of the arc is registered as a LINE END point:

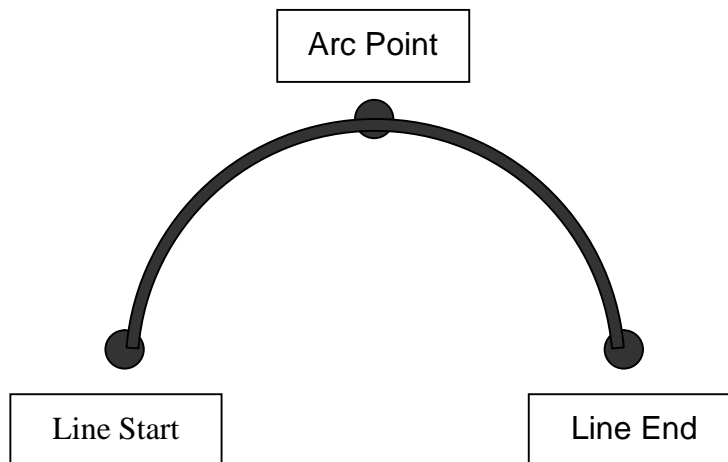

Lines and arcs can also be combined to dispense a bead of material along a complex path: **You cannot have 2 consecutive arc points in a program**

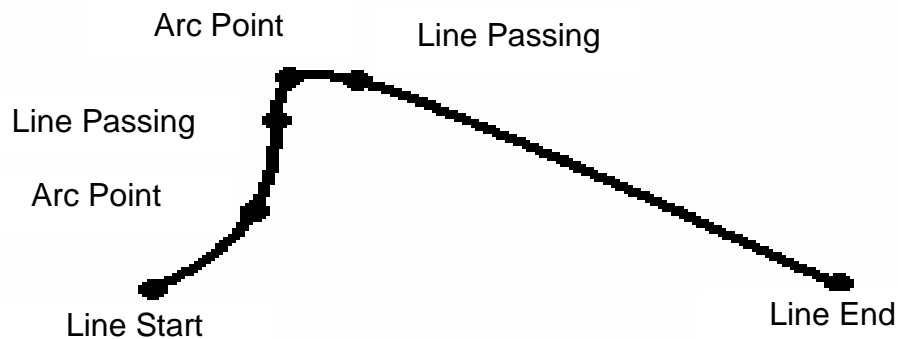

Once the required point locations for your program have been taught, the teach pendant is no longer required. The unit can be switched to RUN mode and operated using the buttons and switches on the main unit control panel.



# SECTION 2: Tour of Teach Pendant

## 2.1 Teach Pendant Overview

The teach pendant enables the user to jog robot to input program data.

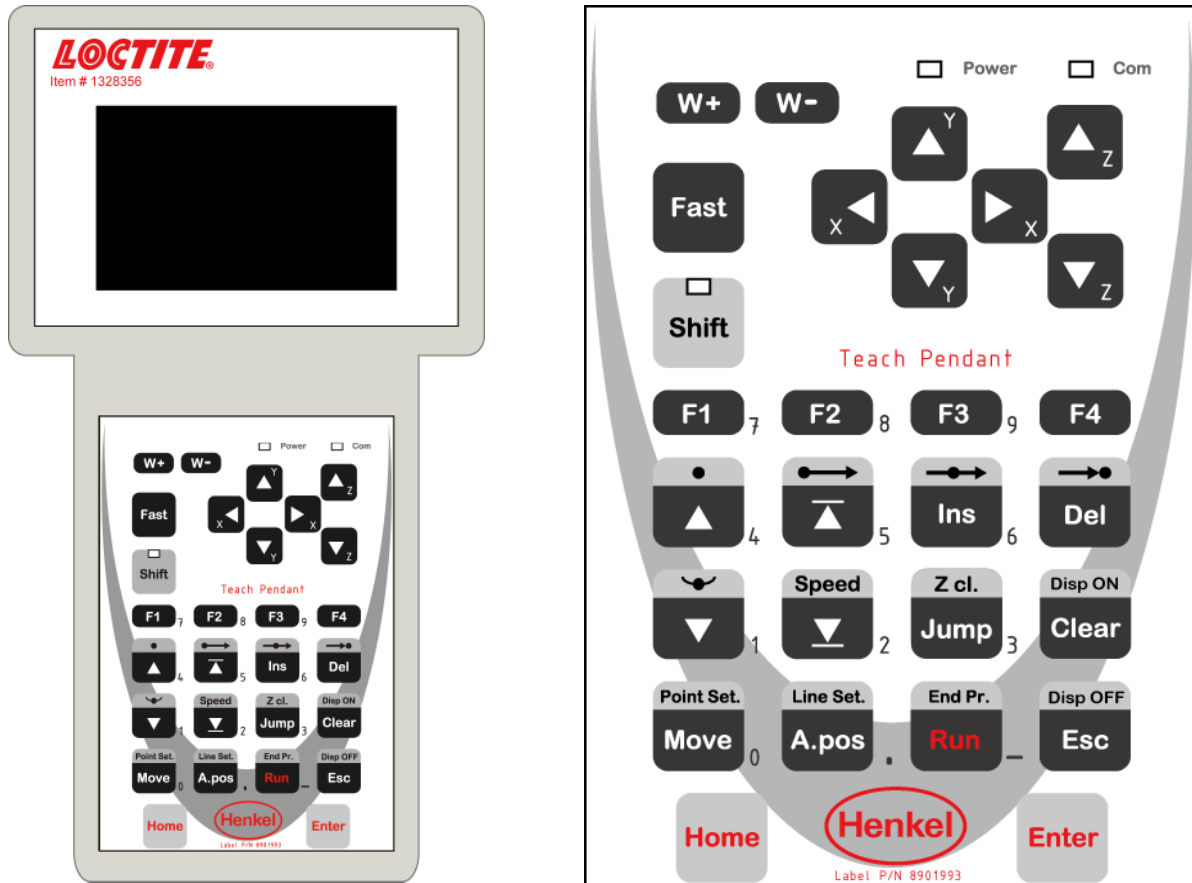





## 2.2 Operation







There are several functions assigned to most keys on the Teach pendant. When a key is pressed alone, the function shown in the dark grey colored area on the key is executed. For example, **Ins**, **Del**, **Jump**, **Clear** and **Esc** are the default key functions, which are executed when that key is pressed alone.



To access the function shown in the light grey area at the top of a key, press and release the **Shift** key first (the LED on the **Shift** key will be flashing), then press the desired key. For example, to select the **Speed** function, press and release **Shift**, then press the **Speed** key.

When a number is required, the teach pendant will automatically switch to numeric entry mode. The number represented by each key is shown in the lower right corner of the key.





## 2.3 Key Introduction

Menu Keys	
	Opens the Point registration menu Select the options shown on the display
	Opens F2 Menu Select the options shown on the display
	Opens F3 Menu Select the options shown on the display
	Opens the F4 Setup menu Select the options shown on the display



Jog Keys	
	Jogs the X-axis in the left direction.
	Jogs the X-axis in the right direction.
	Jogs the Y-axis in the backward direction.
	Jogs the Y-axis in the forward direction.
	Jogs the Z-axis UP.
	Jogs the Z-axis DOWN.
	Accelerates jog speed – used with X+, X-, Y+, Y-, Z Up, Z Down

Navigation Display	
	Moves forward (1) memory address.
	Moves backward (1) memory address.

## 2.4 Navigation Menu

Once the menu is open, use the up and down arrows to move through the items on the menu.	 
Use left and right arrows to change to the next page or previous page of the menu.	 
Press <b>ENTER</b> to select the current item.	

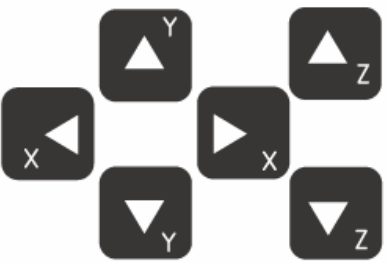
## 2.5 Jogging

The tip is jogged by pressing the jog buttons	
<p>If the <b>FAST</b> button is pressed and held first, then one of the jog buttons is pressed, the axis will be jogged at the maximum jog speed.</p> <p>If one of the jog buttons is pressed first, then the <b>FAST</b> button is pressed, the jog motion will accelerate.</p> <p>If the <b>FAST</b> button is released, the jog motion will decelerate.</p>	















## 2.6 Data Entry













If a numeric value is required, the teach pendant will automatically switch to numeric mode. Use the keys 0 – 9, (.) and the minus sign (-) to enter numbers.

## 2.7 Running a Program





Press the  key to run the program.

## 2.8 Teach Pendant Key Assignments

Key	Function
	Opens the F1 Point registration menu Used to select options shown on the display. The use of this key depends on the current menu displayed.
	Opens the F2 Menu Used to select options shown on the display. The use of this key depends on the current menu displayed.
	Opens the F3 Menu Used to select options shown on the display. The use of this key depends on the current menu displayed.
	Opens the F4 Setup Menu Used to select options shown on the display. The use of this key depends on the current menu displayed.
	Jogs the Z-axis UP.
	Jogs the Z-axis DOWN.
	Jogs the Y-axis in the forward direction.
	Jogs the Y-axis in the backward direction.
	Jogs the X-axis in the left direction.
	Jogs the X-axis in the right direction.
	Accelerates the jog speed when used with X+, X-, Y+, Y-, Z Up, Z Down.
	If Shift is pressed and released, then another key is pressed, the secondary function of that key (shown in light grey) will be executed.
	Inserts a memory address before the current address.
	Deletes the current memory address.

<b>Key</b>	<b>Function</b>
	Clears / erases the numeric value currently shown in the display.
	If pressed once, clears the current numeric value. If pressed twice, cancels the current function. If a program is running, cancels the running program. Changes from Point List display mode to Single Point display when teaching point data.
	Changes the display to memory address number 1.
	Changes the display to the last memory address used in the program.
	Moves back (1) memory address. After opening a menu, use this key to move Up inside the menu.
	Moves forward (1) memory address. After opening a menu, use this key to move Down inside the menu.
	Jumps to a specified memory address
	Moves the tip to the point location currently in the display.
	Adjusts the tips position after a barrel change
	Runs the program.
	(Enter)–used to confirm data entries. Opens the Point registration menu.
	Homes the robot. Initializes all axes and moves the head to the position (0, 0, 0).

**Operating Manual**  
**Section 2: Tour of Teach Pendant**

<b>Key</b>	<b>Function</b>
 + 	Registers a DISPENSE DOT point.
 + 	Registers a LINE START point.
 + 	Registers a LINE PASSING point.
 + 	Registers a LINE END point.
 + 	Registers an ARC POINT.
 + 	Registers a Point Dispense Setup command.
 + 	Registers a Line Dispense Setup command.
 + 	Registers a Line Speed command.
 + 	Registers the End Program command.
 + 	Registers a Z Clearance command.
 + 	Set the dispenser "Off"
 + 	Set the dispenser "On"
 + 	Dry Run Program.
	The use of this key depends on the current menu displayed.
	The use of this key depends on the current menu displayed.

# SECTION 3: MENU Introduction



### 3.1 F1 Menu

Below is a list of Point Types, which are found under the **Enter or F1** key (**F1 Menu**):

<b>Function</b>	<b>Description</b>
<b>Dispense Dot</b>	Registers the current XYZ location as a Dispense point for dot dispensing.
<b>Line Start</b>	Registers the current XYZ location as a Line Start point for line dispensing. This function is also included DISPENSE ON function
<b>Line Passing</b>	Registers the current XYZ location as a Line Passing point. This is a location on the line where the tip changes direction, such as at the corner on a rectangle.
<b>Circle</b>	Registers a circle with the circle center at the current XYZ location. The display will prompt the user for the circle diameter.
<b>Arc Point</b>	Registers the current XYZ location as an Arc point. Arc points are used to dispense material in an arc or circle.
<b>Line End</b>	Registers the current XYZ location as a Line End point. This function also included DISPENSE OFF function
<b>End Program</b>	Registers the current memory address as the end of the program.
<b>Dispense On / Off</b>	Registers an instruction which turns the dispenser on or off at the current XYZ location.
<b>GOTO Address</b>	Causes the program to jump to the specified memory address.
<b>Step &amp; Repeat</b>	Registers an instruction that will re-run a selected group of memory addresses, stepping by a user-defined distance in the X or Y-axis after each copy. The matrix of parts is defined by specifying the number of rows, the number of columns, the X offset and the Y offset.  Step & Repeat <b>X</b> indicates that the robot will give priority to the X-axis, running the parts along the X-axis first.  Step & Repeat <b>Y</b> indicates that the robot will give priority to the Y-axis, running the parts along the Y-axis first.

<b><i>Function</i></b>	<b><i>Description</i></b>
<b>Brush Area</b>	Causes the tip to 'paint' the defined area. The painted area can be in the form of a rectangle or a circle / spiral.
<b>Call Subroutine</b>	Causes the machine to jump to a specified memory address and execute the instructions found there. When the end program instruction is reached, program execution will continue at address just after the call Subroutine instruction.
<b>Call Program</b>	Jumps to the specified program number from within the current program.
<b>Set I/O</b>	Registers an instruction, which either sets the value of an output signal or checks the status of an input signal.
<b>Wait Point</b>	After executing the current point (Line start, passing, etc) the robot will wait a specified amount of time before moving to the next command.
<b>Stop Point</b>	After executing the current point (Line start, passing, etc), the robot will wait until the start button is pressed before moving to the next command.
<b>Home Point</b>	Registers an instruction to 'home' all axes, sending them to the home position. See the F4 Menu for instructions on changing the location of the home position.
<b>Loop Address</b>	Causes the program to execute a group of memory addresses a user-specified number of times.
<b>Dummy Point</b>	Registers the current XYZ location as a Dummy point. The tip will simply pass through this point. Useful for avoiding obstacles on the work piece.
<b>Initialize</b>	Registers an Initialize point. Causes the robot to perform a mechanical initialization.
<b>Label</b>	Registers a label that can be used as a reference when used with the GOTO address, Loop address, Set I/O, Step & repeat X, Step & repeat Y and Call Subroutine commands.
<b>Display Counter</b>	Shows a counter at the bottom of the teach pendant screen while a program is running.
<b>Loop Counter</b>	To setup the "Loop Counter" to "Keep" or "Clear"

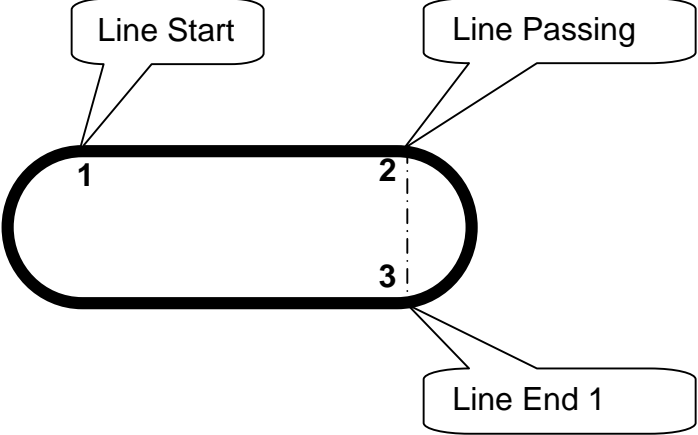
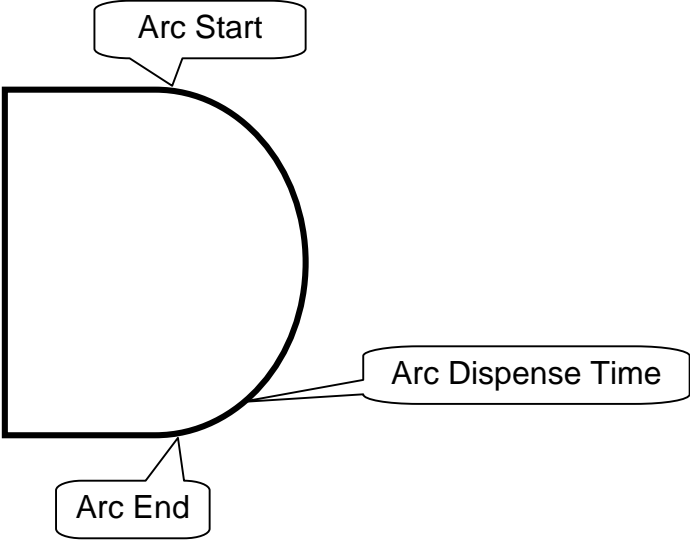
<p><b>Line End 1</b></p>	<p>Registers the current memory address as the end of the “Stadium” path setting:</p> 
<p><b>Dispense Output Setup</b></p>	<p>Register the assigned output port (0 – 8) ON or OFF controlled by LINE START and LINE END (same as dispenser port)</p>
<p><b>Needle Adjustment</b></p>	<p>Register the “Needle Adjustment” command in the first address. System will perform Needle calibration automatically before Dispensing.</p>
<p><b>Needle Adjustment Counter</b></p>	<p>Set up needle adjustment counter numbers. While the number reached, system performs needle calibration.</p>
<p><b>Arc Dispense Setup</b></p>	<p>Set up valve on time for arc dispensing. Similar the Tail Length fictional but it's control by times.</p> <p>Arc Dispense time can control valve pre-shut off during arc dispensing. i.e. If dispense time for a complete arc need 5 sec, and set 4 sec in arc dispense time, than valve will pre-shut off 1 sec before are end point.</p> 



---

## 3.2 F2 Menu

---

Below is a list of functions, which are found under the **F2** key (**F2 Menu**):

<b>Function</b>	<b>Description</b>
<b>Group Edit</b>	Allows a function to be applied to a user-defined group of memory addresses. Functions include copy, delete, move, multiply line speed, multiply dispense times, apply X Offset, apply Y Offset, apply Z Offset
<b>Expand Step &amp; Repeat</b>	Expands the memory address locations which would be performed at a Step & Repeat instruction so individual memory addresses of the repeated instructions can be edited
<b>Program Name</b>	Allows the user to register a name for the current program number
<b>Z-axis Limit (mm)</b>	Sets the MAXIMUM Z-axis value (the lowest tip position). Once the Z-axis limit is set, the robot will prevent the tip from jogging below the set location.
<b>Initial Output Port</b>	Sets the status of the output signals when the machine is initialized
<b>Utility Menu</b>	Opens the Utility Menu. See <b>3.2.1 Utility Menu</b>

---

### 3.2.1 Utility Menu

---

Below is a list of functions, which are found under **F2 Menu -> Utility Menu**:

<b><i>Function</i></b>	<b><i>Description</i></b>
<b>Program</b>	Opens the Program utility menu. Allows programs to be copied, backed up, restored, or cleared.
<b>Memory</b>	Opens the Memory utility menu. Allows the robot memory to be backed up, restored, or cleared.
<b>Teach Pendant</b>	Opens the Teach Pendant utility menu. Allows the current program to be copied to the Teach Pendant for transferring to another robot.
<b>Relocate Data</b>	Allows the position of a program to be corrected using two reference points. Corrects for X offset, Y offset and angle of rotation.
<b>Lock Program</b>	Locks or unlocks a program to enable or disable program editing
<b>Password Setup</b>	Allows the password to be set or reset for the current program. Protects the program from unauthorized editing.
<b>Key Beep</b>	Enabling Key Beep to produce a beep every time a key in the Teach Pendant is touched.
<b>Test Function</b>	Testing the Robot Sensor, Panel Connector, Input Output signal, Teach Pendant and Motor.

### 3.3 F3 Menu

---

Below is a list of functions, which are found under the **F3** key (**F3 Menu**):

<b><i>Function</i></b>	<b><i>Description</i></b>
<b>Numerical Move</b>	Allows the tip to be positioned numerically by entering a number for the X, Y and Z values.
<b>Save Temp Point</b>	Saves the current XYZ position in a temporary memory area numbered 1 – 9.
<b>Move To Temp Point</b>	Retrieves a XYZ position, which was stored with Save Temp Point.
<b>Undo Program</b>	Cancels the last change to the program. Returns to the program state prior to the last change.
<b>Redo Program</b>	Restores the last change to the program, which was canceled with Undo.
<b>Debug Program</b>	Runs the program in Debug mode starting at the current point location.
<b>Move To Home Position</b>	Causes the tip to move to the home position. The default home position is X=0, Y=0, Z=0
<b>System Information</b>	Displays system information, including software version number, work area size and control board version
<b>Execute Point</b>	Runs a selected command.
<b>Program Name List</b>	Displays the program list with program number and program name

### 3.4 F4 Menu

Below is a list of functions, which are found under the **F4** key (**F4 Menu**):

<b>Function</b>	<b>Description</b>
<b>Line Speed</b>	Registers the LINE SPEED used for all lines from the current memory address forward until another Line Speed instruction is found.
<b>Line Dispense Setup</b>	Registers the LINE DISPENSE SETUP values which sets dispensing wait time at the start of lines ('head' time), wait time at the passing points ('Node' time) and waiting time at the end of lines ('tail' time). The registered values will be used from the current memory address forward until another Line Dispense Setup instruction is found.
<b>Point Dispense Setup</b>	Registers POINT DISPENSE SETUP values, which sets dispensing time and waiting time at the end of dispensing ('tail' time) for dots. The registered values will be used from the current memory address forward until another POINT DISPENSE SETUP instruction is found.
<b>Dispense End Setup</b>	Registers the height and speed the tip should raise at the end of dispensing. The registered values will be used from the current memory address forward until another DISPENSE END SETUP instruction is found.
<b>Z Clearance</b>	Registers the additional distance the tip should rise, beyond the height set in Dispense End Setup, to allow obstacles to be cleared as the tip moves from one figure to another. Values will be used until another Z Clearance instruction is found.
<b>XY Move Speed</b>	Sets the movement speed of the X and Y axes when moving from one figure to another in the program
<b>Z Move Speed</b>	Sets the movement speed of the Z-axis when moving from one figure to another in the program
<b>Home Position Setup</b>	Changes the position the robot moves to at the end of a program cycle.



<b><i>Function</i></b>	<b><i>Description</i></b>
<b>Adjust Position Setup</b>	Registers the current XYZ location as the Adjust Position. This reference point can later be used to correct the program location after the dispensing tip has been changed.
<b>Retract Setup</b>	Registers Retract values at the current XYZ location. Retract causes the tip to move up and back over the dispensed bead after line dispensing.
<b>Quickstep</b>	Causes the robot to move very fast from one point to another reducing the time of the dispensing cycle.
<b>Auto Purge Setup</b>	Automatically purges the system at the end of the program.
<b>ESTOP Output Status</b>	After receiving the emergency stop signal, ESTOP Output Status can modify the status of all the outputs or leave them as before receiving the emergency signal.
<b>Acceleration</b>	Parameter that controls the robot's acceleration
<b>Pause Status</b>	Sets the position to which the tip moves after pressing the Start button. The tip can go to the Home position or will stay at the position where the Start button was pressed.
<b>Language</b>	Opens MENU for selecting the Language
<b>Jog Speed</b>	Allows the user to set the tip jog speed for teach mode: Low, Middle or High jog speed can be selected.
<b>Debug Speed (mm/s)</b>	Sets the speed used when running in Debug mode.
<b>Adjust Origin</b>	See Section 5.4.9 "Adjust Position Setup"
<b>Quickstep Path</b>	To setup the move up shape of Z-axis. "Triangle Shape" or "Normal Shape" Need to use with function "Quickstep".
<b>USB Up/Down Load</b>	Upload and Download program files via USB port. See Section 5.4.21
<b>Circle Delay Time</b>	Set up dispensing delay time if used over angle at Circle command.
<b>Initialize Setup</b>	Allow machine performing HOMING by each of cycle.
<b>Teach Needle Adjustment</b>	Allow the user to set up the location of needle calibration tools. See Section 5.4.24

<b>Needle Adjustment Setup</b>	Setup Needle calibration method and calibrate repeat times. See Section 5.4.25
--------------------------------	---

# SECTION 4: Programming

## 4.1 Programming Example





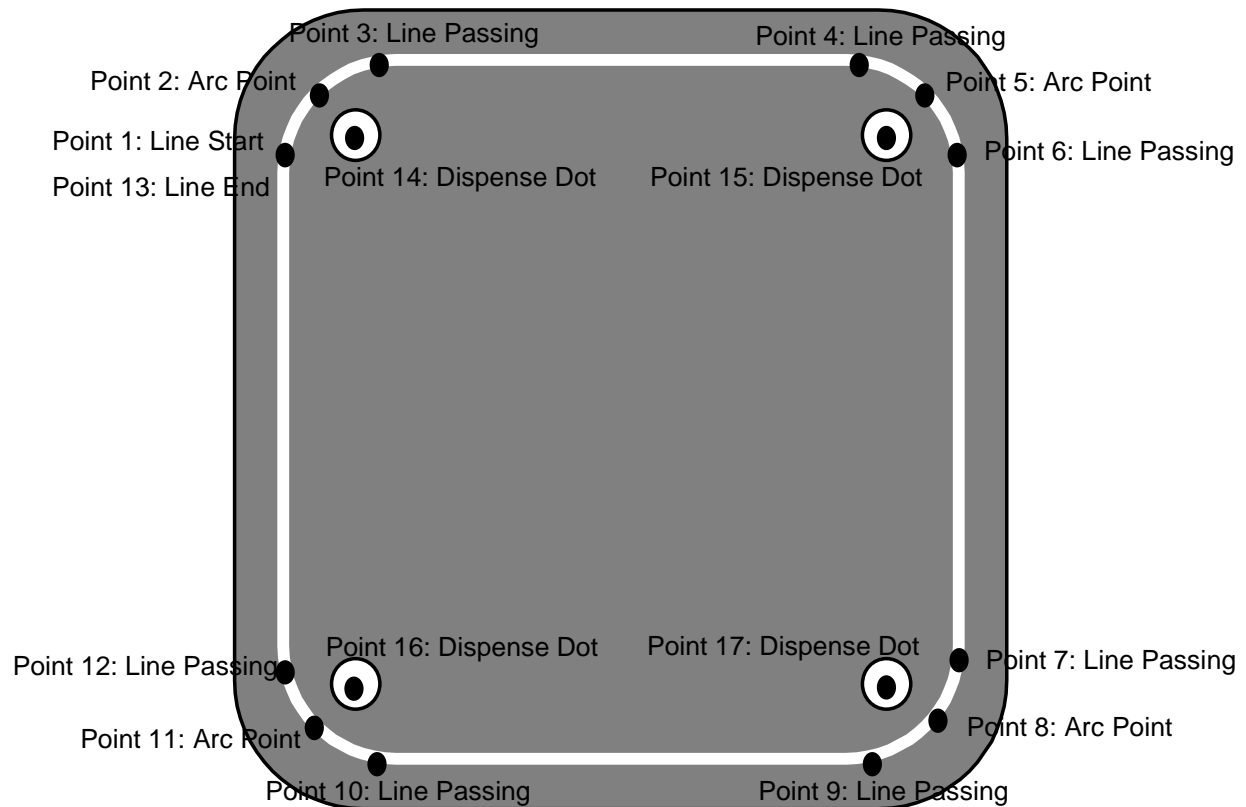

---















To help you become familiar with programming the robot, please follow the instructions below to create a program, which dispenses in the following pattern (White Path):







### Notes:

- We will create the above program in program # 5.
- We will use a line speed of 50 mm / second for the lines and arcs in the program
- For dots, we will use a dispensing time of 1.5 seconds and a waiting time of 0.2 seconds after dispensing

	<i>Instruction</i>	<i>Display Shows</i>
1	Follow the instructions found in <i>Error! Reference source not found.</i> <b>Setup</b> to setup the robot.	
2	Select program <b>5</b> using the program number selection switches on the main unit control panel. Turn the power on.	[MACHINE HOME]   START/HOME
3	Press the <b>START</b> button. The robot will move to the home position.	ADDR:1      PROG:5 EMPTY  X:0.00 Y:0.00 Z:0.00
4	Press the  +  to register a line speed of 50 mm/second at memory address number 1.	Line Speed Setup -----:  unit: mm/sec
5	The robot is now waiting for the speed to be registered. Press <b>50</b> then <b>ENTER</b> to register a speed of 50 mm / second.	ADDR:2      PROG:5 EMPTY
6	The display shows we are at memory address 2 and that it is empty.  Jog the dispensing tip to the first location in the diagram above (1: Line Start).  To jog the X and Y-axes, press the arrow keys <b>X←</b> , <b>→</b> , <b>Y↑</b> and <b>Y↓</b> . To jog the Z-axis, press the <b>Z↑</b> and <b>Z↓</b> keys.  Press and hold the <b>FAST</b> key to jog fast. See 2.5 <b>Jogging</b> for more information.	
7	Once the tip is at the correct X, Y, Z location for the first point ( <b>1:Line Start</b> ), press the  +  to register the location as a Line Start point. P.S.: No need to set “Dispense ON” since “Line Start” has already included this function	ADDR: 3      PROG: 5 EMPTY
8	The display will show we are at memory address 3 and it is empty. Jog the tip to the X, Y, Z location of the second point ( <b>2: Arc Point</b> ).  When the location is correct, press the  +  to register the location as a Line Passing point.	ADDR: 4      PROG: 5 EMPTY

	<i>Instruction</i>	<i>Display Shows</i>
9	<p>Now jog the tip to the location of the third point (<b>3: Line Passing</b>). When the location is correct, press the  +  to register the location as an Arc point.</p>	<p>ADDR: 5      PROG: 5 EMPTY</p>
10	<p>Jog the tip to the location of the fourth point (<b>4: Line Passing</b>). When the location is correct, press the  +  to register the location as a Line Passing point.</p>	<p>ADDR: 6      PROG: 5 EMPTY</p>
11	<p>Repeat the step 8 – 10 to register the points 5 to 12</p>	
12	<p>Jog the tip to the location of the thirteenth point (<b>13: Line End</b>). When the location is correct, press the  +  to register the location as a Line End point.</p>	<p>ADDR: 15      PROG: 5 EMPTY</p>
13	<p>The line is now complete. The next step is to register the dispense settings for the dots. Press the  +  to register the dot dispensing time.</p>	<p>Point Dispense Setup -----Time: Tail Time: unit: sec</p>
14	<p>Type <b>1.5</b> to register a dispensing time of 1.5 seconds, then press <b>ENTER</b>. Type <b>0.2</b> to register a waiting time after dispensing of 0.2 seconds, then press <b>ENTER</b>.</p>	<p>ADDR: 16      PROG: 5 EMPTY</p>
15	<p>Jog the tip to the location of first dispense dot (<b>14: Dispense Dot</b>). When the location is correct, press the  +  to register the location as a Dispense Dot.</p>	<p>ADDR: 17      PROG: 5 EMPTY</p>
16	<p>Jog the tip to the location of second dispense dot (<b>15: Dispense Dot</b>). When the location is correct, press the  +  to register the location as a Dispense Dot.</p>	<p>ADDR: 18      PROG: 5 EMPTY</p>
17	<p>Jog the tip to the location of third dispense dot (<b>16: Dispense Dot</b>). When the location is correct, press the  +  to register the location as a Dispense Dot.</p>	<p>ADDR: 19      PROG: 5 EMPTY</p>

	<i>Instruction</i>	<i>Display Shows</i>
18	<p>Jog the tip to the location of fourth dispense dot (17: <b>Dispense Dot</b>). When the location is correct, press the  +  to register the location as a Dispense Dot.</p>	<p>ADDR: 20    PROG: 5 EMPTY</p>
19	<p>The program is now complete. Press the  +  to register address 20 as the END of the program.</p>	<p>ADDR: 21    PROG: 5 EMPTY</p>
20	<p>To run the program, press the  key.</p>	

---

## **4.2 Good Programming Practices**

---

It is recommended to register the setup commands at the beginning of every program.

The following setup commands are the most commonly used:







- Dispense End Setup
- Point Dispense Setup
- Line Dispense Setup
- Line Speed
- Z Clearance
- Retract Setup
- Adjust Position Setup

For a complete list and description of all the different setup commands, refer to **SECTION 3.4 F4 Menu** and **SECTION 5.4 F4 Menu**.





## 4.3 Editing a Program

You can move through the instructions in an existing program by using the following keys:

Key	Function
	Moves forward (1) memory address
	Moves backward (1) memory address
	Moves to the first memory address in the program
	Moves to the last programmed memory address in the program
	Moves the tip to the XYZ point location of the selected point
	Jumps to display the specified memory address

### 4.3.1 Changing a Point's XYZ location

To change the XYZ location of a point, press the  or  key until the point you want to change is shown in the display.

You can confirm that the correct point is in the display by pressing the  key. This will cause the tip to move to the XYZ position shown in the display.



Now use the jog keys ( $X\leftarrow$ ,  $\rightarrow X$ ,  $Y\uparrow$  and  $Y\downarrow$ ) and the  $Z\uparrow$  /  $Z\downarrow$  keys to jog the tip to the new location.

Once the location is correct, simply re-register the point as you did when it was first taught,

by pressing the  key and selecting the point type. The point will be re-registered at the new location.

### 4.3.2 Insert / Delete an Instruction

---

- To insert an instruction, press the  key. The point currently shown in the display will be moved forward one memory address. A new, empty memory address will be inserted at the current memory address.
- To delete the instruction currently shown in the display, press the  key, and then press the  (Yes) key.

---

## 4.4 *Changing the Program Number*

---

The program number is selected by the program number selection switches on the main unit's control panel.



Press the + and – buttons to select the program number.

Note: Program 99 is designed for “autorun” on Run mode. When starting the robot with this program, the robot starts automatically **without** pressing the Start/Home key for initialization.

---

## 4.5 *Changing from Teach Mode to Run Mode*

---

To change from Teach mode to Run mode, change the position of the mode switch on the main unit's control panel.

When the machine is in Run mode, the teaching box (teach pendant) is not required. Programs can be selected and run using the switches on the front control panel of the main unit.

# SECTION 5: Function Reference

---

## 5.1 F1 Menu (Enter or F1 Key)

---

Below is a list of functions which are found under the **ENTER** or **F1** key. These functions are 'point-type' functions, meaning that the values applied will occupy one memory address.

Please see **SECTION 6: Sample Programs** for additional programming examples.

---

### 5.1.1 Dispense Dot

---

Registers the current XYZ location as a dispense point for dot dispensing.

The dispense time and wait time must be set in a previous memory address by registering a **Point Dispense Setup** instruction.

The upward motion of the tip after dispensing can be controlled by registering a **Dispense End Setup** instruction and / or a **Z Clearance** instruction in a previous memory address.

**Dispense End Setup** and **Z Clearance** instructions are registered using the **F4** key.

See also **5.4.3 Point Dispense Setup**, **5.4.4 Dispense End Setup** and **5.4.5 Z Clearance**.

---

### 5.1.2 Line Start

---

Registers the current XYZ location as a Line Start point for line dispensing.

The line speed must be set in a previous memory address by registering a **Line Speed** instruction using the **F4** key.

Dispense delay times used at Line Start and Line End points can be controlled by registering a **Line Dispense Setup** instruction in a previous memory address. The **Line Dispense Setup** instruction is registered by pressing the **F4** key.

See also **5.4.1 Line Speed** and **5.4.2 Line Dispense Setup**.

---

### 5.1.3 Line Passing

---

Registers the current XYZ location as a Line Passing point. This is a location on the line where the tip changes direction, such as at the corner on a rectangle.

Also use a Line passing point before and after an Arc Point instruction.

---

### 5.1.4 Circle

---

Registers a circle, where the circle's center is at the current XYZ location. To register a circle, jog the tip to the circle's center and press **ENTER**, and then press the key 4 (for circle). The display will prompt you to type the following data:

Diameter: Type the diameter of the circle and press **ENTER**.

Over Angle: (The value is from 1~360). After dispensing the circle, while going through an extra part of the circle defined by the Over Angle, the dispenser will be turned OFF.

Z Lift: 1. Yes 2. No

Selection: If you want the Z-axis (tip) to lift while going through the Over Angle, you must select 1. Otherwise: select 2.

The speed must be set in a previous memory address by registering a **Line Speed** instruction using the **F4** key.

Dispense delay times used at the start of the circle and at the end of the circle can be controlled by registering a **Line Dispense Setup** instruction in a previous memory address. The **Line Dispense Setup** instruction is registered by pressing the **F4** key.

See also **5.4.1 Line Speed** and **5.4.2 Line Dispense Setup**.

The upward motion of the tip after dispensing can be controlled by registering a **Dispense End Setup** instruction and / or a **Z Clearance** instruction in a previous memory address.

**Dispense End Setup** and **Z Clearance** instructions are registered using the **F4** key.

See also **5.4.4 Dispense End Setup** and **5.4.5 Z Clearance**.

---

### 5.1.5 Arc Point

---

Registers the current XYZ location as an Arc Point. Arc points are used to dispense material along an arc or circular path.

See SECTION 4: **Programming Example**, for an example of the use of an Arc point.

---

### 5.1.6 Line End

---

Registers the current XYZ location as a Line End point.

The dispense delay time used at the end of the line can be controlled by registering a **Line Dispense Setup** instruction in a previous memory address. The **Line Dispense Setup** instruction is registered by pressing the **F4(SETUP)** key.

See also **5.4.2 Line Dispense Setup**.

The upward motion of the tip after dispensing can be controlled by registering a **Dispense End Setup** instruction and / or a Z Clearance instruction in a previous memory address.

**Dispense End Setup** and **Z Clearance** instructions are registered using the **F4(SETUP)** key.

---

### 5.1.7 End Program

---

Registers the current memory address as the end of the program. The end program instruction will cause the tip to return to the home position at the end of the program cycle.

---

### 5.1.8 Dispense ON / OFF

---

The Dispense ON / OFF instruction will allow the user to program an instruction which will turn the dispenser ON or OFF.

This is useful for turning the dispenser OFF before the end of a line to prevent excess material at the line end.

**Problem:** Too much material at the end of the line



**Solution:** Turn the dispenser OFF before the end of the line

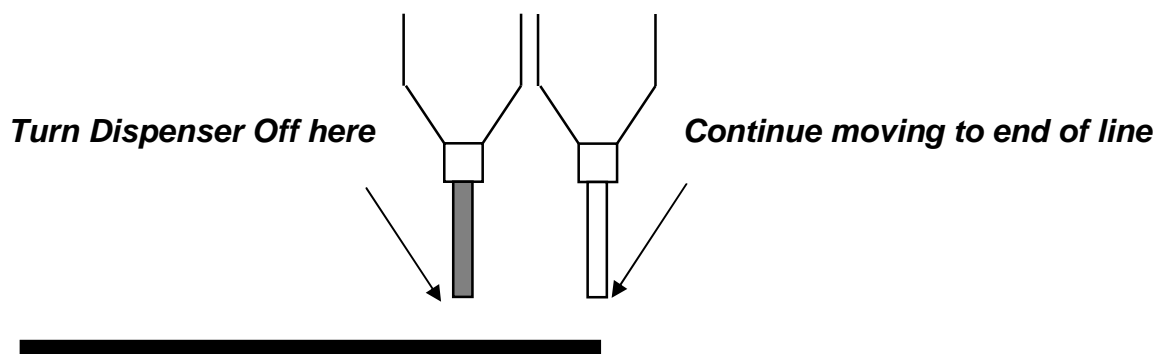

To register a DISPENSE OFF instruction, jog the tip to the XYZ location where you want the dispenser OFF, enter that location as a Line Passing point, then press the **ENTER** key and select **Dispense ON / OFF**.

Press **1** to select Dispenser ON, or press **2** to select Dispenser OFF.



---

### 5.1.9 GOTO Address

---

The GOTO Address function causes the program to jump to a specified memory address.

---

### 5.1.10 Step & Repeat X

---

Step & Repeat X allows a group of instructions to be run repeatedly, stepping a given distance in the X-axis or Y-axis between each cycle.

Step & Repeat X is useful when a fixture is mounted on the robot, which holds many identical work pieces aligned in rows and columns. The user needs only to create a program for the first work piece in the fixture, and then use the Step & Repeat function to dispense to the other work pieces.

The Step & Repeat function will allow the user to define the number of rows, the number of columns, the X Offset between each part, and the Y Offset between each part.

If, for example, we have a program (number 20) which dispenses three dots of material on a work piece:

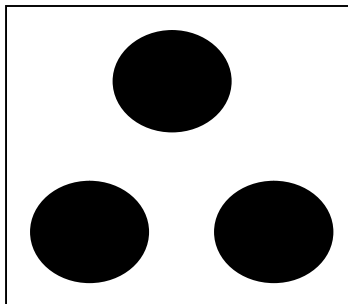

The program would consist of the following seven instructions:

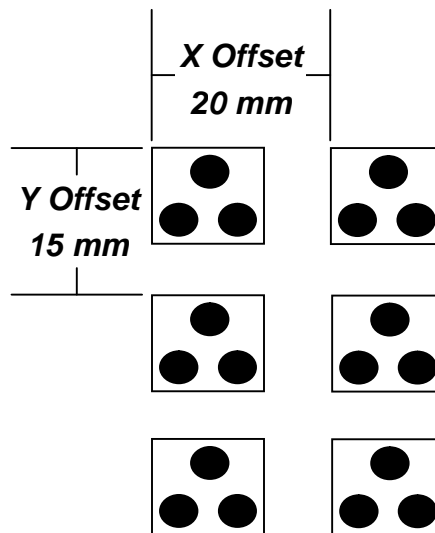

<b>Address</b>	<b>Instruction</b>
1	Dispense End Setup: H. Speed = 60 mm/s, L. Speed = 10 mm/s, L. Length = 5mm
2	Z Clearance: Relative 6 mm
3	Point Dispense Setup: Disp. Time = 0.5 s Tail Time = 0.20 s
4	Dispense Point
5	Dispense Point
6	Dispense Point
7	End Program

If a fixture is made which holds (6) work pieces, in two columns by three rows:



A Step & Repeat X instruction can be used to repeat the program at the additional (5) locations.

The instruction at memory address 7 should be changed from End Program to Step & Repeat X. To register a Step & Repeat X instruction at memory address 7, do the following:

	<i>Instruction</i>	<i>Display Shows</i>
1	Press the  or  keys until memory address 7 is shown in the display	ADDR: 7            PROG: 20 End Program
2	Press the <b>Enter</b> key, then press the  key to change to page 2. Select <b>Step &amp; Repeat</b> by pressing the key 3.	Step & Repeat Address, 7 -----Y, Start Address, Columns (X): Rows (Y):
3	Type <b>1</b> to select X direction, then press <b>ENTER</b> .	Step & Repeat Address, 7 -----Y, 1 Start Address, Columns (X): Rows (Y): [w+] Address [w-]Label
4	The display will prompt you for the <i>Start Addr</i> :  The start address is the memory address of the first instruction, which is part of this Step & Repeat group.  In our example, we want to repeat all instructions starting with memory address number 4.  Type <b>4</b> to specify memory address 4, then press <b>ENTER</b> .	Step & Repeat Address, 7 -----Y, 1 Start Address, 4 Columns (X): Rows (Y):
5	Type <b>2</b> to specify two columns, then press <b>ENTER</b> .	Step & Repeat Address, 7 -----Y, 1 Start Address, 4 Columns (X): 2 Rows (Y):

	<i>Instruction</i>	<i>Display Shows</i>
6	Type <b>3</b> to specify three rows, then press <b>ENTER</b> .	Step & Repeat Address, 7 -----set: Y Offset:  Unit: mm
7	In the above example, the X Offset between parts is 20 mm.  Type <b>20</b> to specify an X Offset of 20 mm, then press <b>ENTER</b> .	Step & Repeat Address, 7 -----set: 20 Y Offset:  Unit: mm
8	In the above example, the Y Offset between parts is 15 mm.  Type <b>15</b> to specify 15 mm, then press <b>ENTER</b> .	Step & Repeat Address, 7 -----Path 2. N Path Select:
9	The display will prompt you to select <i>1. S Path</i> or <i>2. N. Path</i> .  Selecting <i>S Path</i> will cause the first row 1 to 2 to be dispensed, then the second row 2 to 1, and then the third row 1 to 2.  Selecting <i>N PATH</i> will cause the first row 1 to 2 to be dispensed, then the second row 1 to 2, and then the third row 1 to 2.  Press <b>1</b> to select <b>S PATH</b> , then press <b>ENTER</b> .	Addr: 8                      Prog: 20 Empty
10	The program is now complete.  Press <b>ENTER</b> , and then select End Program to mark address 8 as the new <b>End Program</b> instruction.  Press the 7 key then press ENTER.  Press <b>RUN</b> to run the program.	Addr: 8                      Prog: 20 Empty

The program will run in the following pattern and consists of the following instructions:

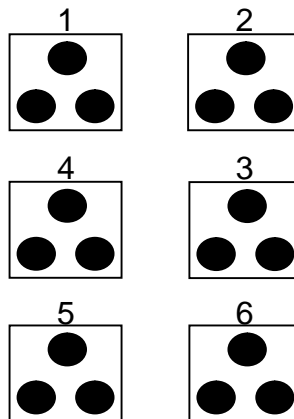

<b>Address</b>	<b>Instruction</b>
1	Dispense End Setup: H. Speed = 60 mm/s, L. Speed = 10 mm/s, L. Length = 5mm
2	Z Clearance: Relative 6 mm
3	Point Dispense Setup: Disp. Time = 0.5 s Tail Time = 0.20 s
4	Dispense Point
5	Dispense Point
6	Dispense Point
7	Step & Repeat X: Cols: 2, Rows: 3, X Off: 20mm, Y Off: 15mm, Addr. 4, S Path
8	End Program

The previous example was done using S Path. The difference between S Path and N Path is the order in which the pieces are run:

**Step & Repeat X:**

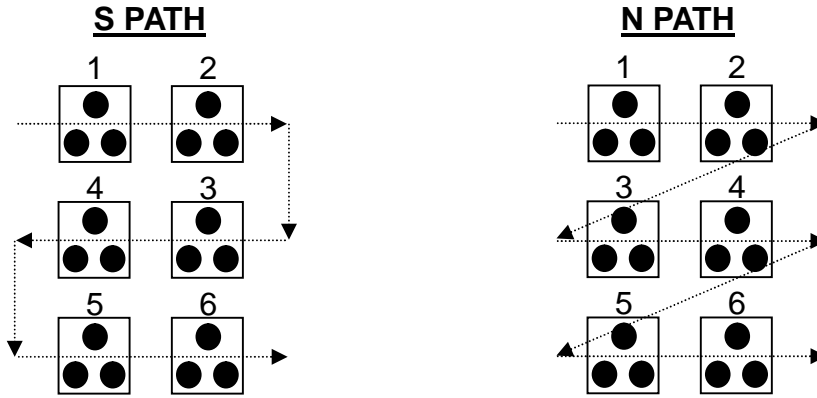

**5.1.11 Step & Repeat Y**

Step & Repeat Y works just as Step & Repeat X does, with one difference: priority is given to the Y-axis instead of the X-axis.

**Step & Repeat Y - S PATH**

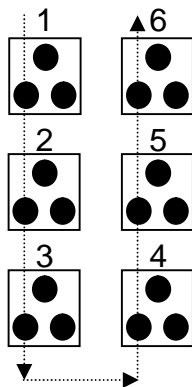

**Step & Repeat Y - N PATH**

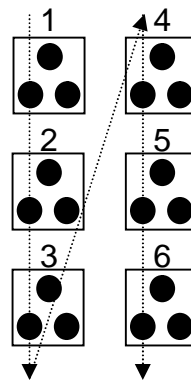

### 5.1.12 *Brush Area*

The Brush Area command causes the tip to 'paint' a defined area.

There are six Brush Area types: Rectangle, Circle, Rectangle 1, Rectangle Band, Circle Band and Circle1. The next pages provide a detailed description of all the Brush area types.

To register a *Brush Area* command, follow the instructions below.

	<i>Instruction</i>	<i>Display Shows</i>
1	Press <b>F1(ENTER)</b> to open the F1 Menu	[POINT]            1/3 1 Dispense Dot 2 Line Start . . 7 End Program
2	Press  , to go to page 2	[POINT]            2/3 . . <b>4 Brush Area</b> .
3	Press <b>4</b> to select Brush Area.	Brush Area Setup -----tangle    4.Rect Band 2.Circle            5.Circle Band 3.Rectangle 1    6. Circle 1 Select:
4	Press the numeric key corresponding to the brush area type then press <b>ENTER</b>	Brush Area Setup -----tangle    4.Rect Band 2.Circle            5.Circle Band 3.Rectangle 1    6.Circle 1 <b>Width(mm) :</b> <b>Band(mm) :</b>
5	Type the width value and press <b>ENTER</b> .  Type the band value and press <b>ENTER</b> .  Width and band values will be explained further in this section.	

---

### 5.1.12.1 *Brush Area: Rectangle*

---

Brush Area Rectangle causes the tip to 'paint' the defined area by passing back and forth along the X-axis, while moving the Y-axis a determined *Brush Width* distance after each pass along the X-axis.

After registering the Brush Area Rectangle command, teach a Line Start point at the top left corner of the area to be brushed and a Line End point at the bottom right corner of that area (the tip will not dispense a straight line between these two points):

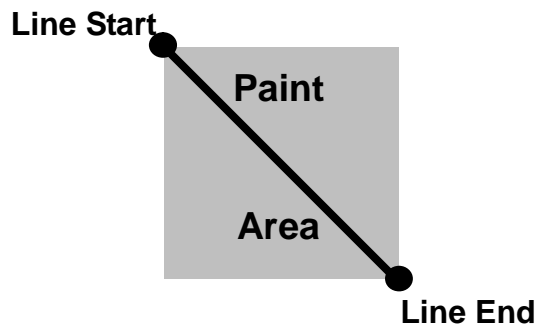

If, for example, a brush width of 6 mm was used, the tip will take the following path when the program is run:

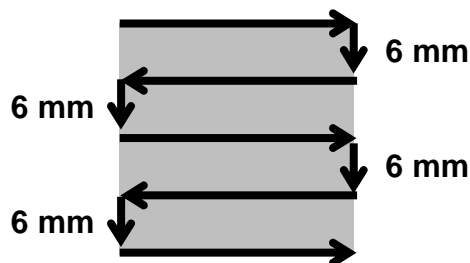



### 5.1.12.2 *Brush Area: Circle*

Brush Area Circle causes the tip to 'paint' the defined area by following a spiral path from the outside limit of the circle to the center of the circle. It works in reverse of the Circle 1 function.

After registering the Brush Area Circle command, jog the tip to a point on the outside limit of the circle to be brushed and register that location as a Line Start point. Then jog the tip directly across to the center of the circle and register that location as a Line End point (the tip will not dispense a straight line between these two points):

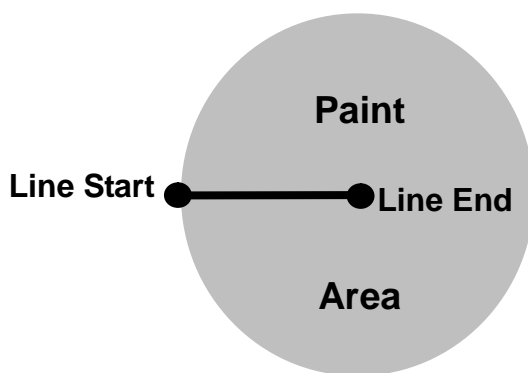

If, for example, a brush width of 5 mm was used, the tip will take the following path when the program is run:

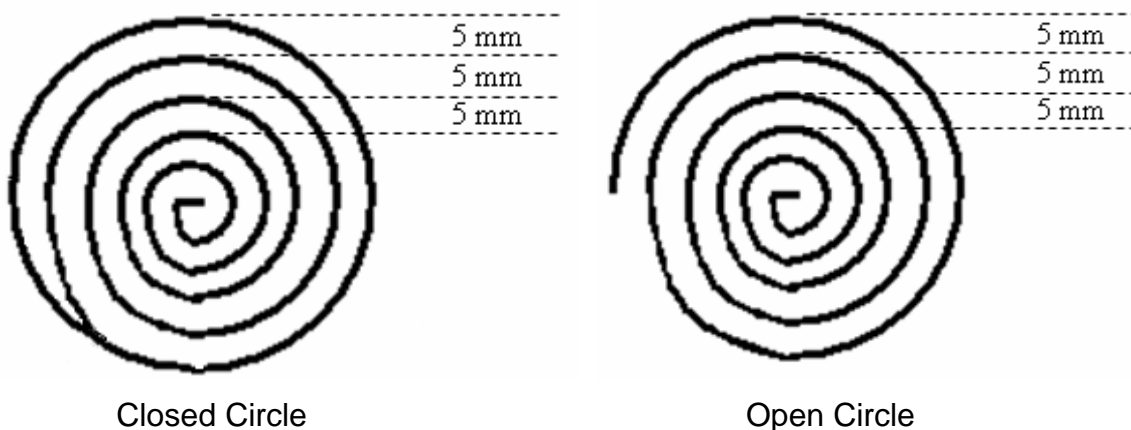

An open or closed option is also available for this function. Selecting the Closed option will make a whole circle first before making the spiral. Selecting the Open option will make the spiral without closing the outer circle.

---

### 5.1.12.3 *Brush Area: Rectangle 1*

---

Brush Area Rectangle 1 causes the tip to 'paint' the defined area by following a square spiral path from the outside of the rectangle to the center.

After registering the Brush Area Rectangle 1 command, teach a Line Starting point at the top left corner of the area to be brushed and a Line End point at the bottom right corner of that area (the tip will not dispense a straight line between these two points):

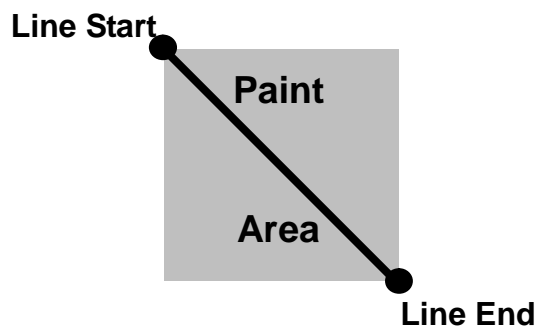

If, for example, a brush width of 5 mm was used, the tip will take the following path when the program is run:

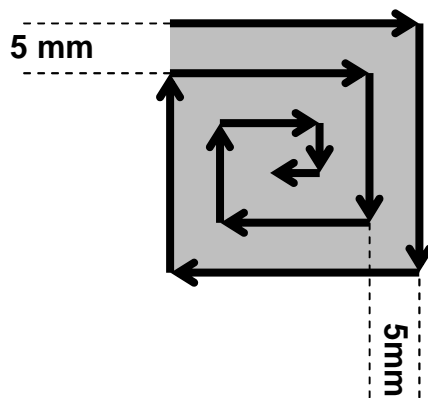

---

### 5.1.12.4 *Brush Area: Rect. Band*

---

Brush Area Rect. Band causes the tip to 'paint' a defined rectangular band area by following a square spiral path from the outside of the rectangle to the center.

After registering the Brush Area Rect. Band command, teach a Line Start point at the top left corner of the area to be brushed and a Line End point at the bottom right corner of that area (the tip will not dispense a straight line between these two points):

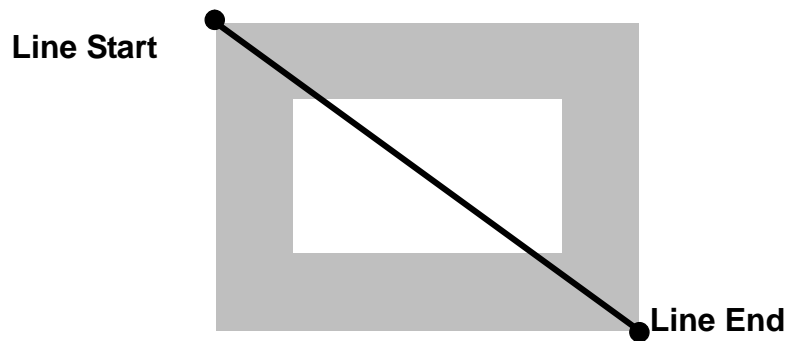

If, for example, a brush width of 5 mm and band of 10mm was used, the tip will take the following path when the program is run:

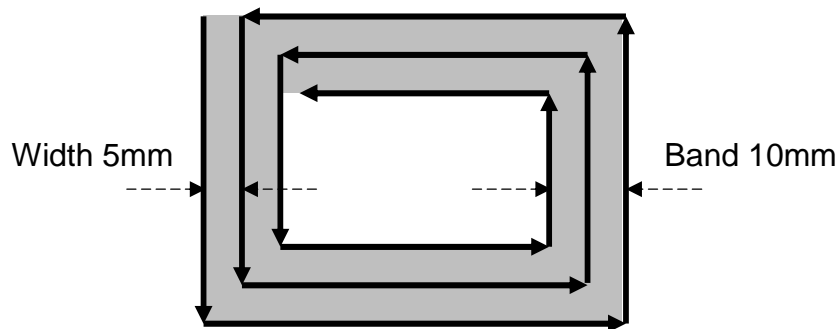

---

### 5.1.12.5 *Brush Area: Circle Band*

---

Brush Area Circle Band causes the tip to 'paint' a defined circular band area by following a spiral path from the outside limit of the circle to the center of the circle.

After registering the Brush Area Circle Band command, jog the tip to a point on the outside limit of the circle to be brushed and register that location as a Line Start point. Then jog the tip directly across to the center of the circle and register that location as a Line End point (the tip will not dispense a straight line between these two points):

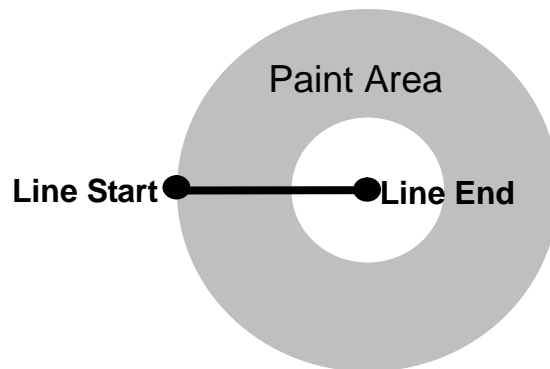

If, for example, a brush width of 5 mm and Band of 15mm was used, the tip will take the following path when the program is run:

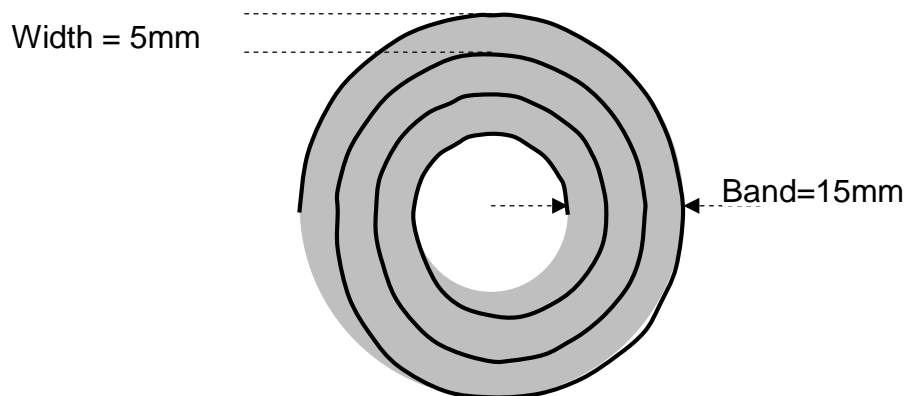

### 5.1.12.6 *Brush Area: Circle 1*

Brush Area: Circle 1, causes the tip to 'paint' the defined area by following a spiral path from the center of the circle to the outside limit of the circle. It works in reverse of the Circle function.

After registering the Brush Area Circle command, jog the tip to a point where you want to register the center of the circle and register that location as a Line Start. Then jog the tip directly across on the outside limit of the circle to be brushed and register that location as a Line End point (the tip will not dispense a straight line between these two points):

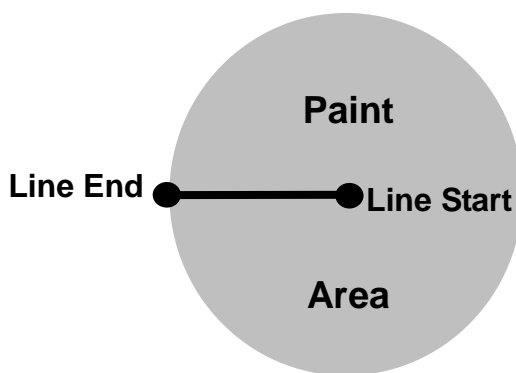

If, for example, a brush width of 5 mm was used, the tip will take the following path when the program is run:

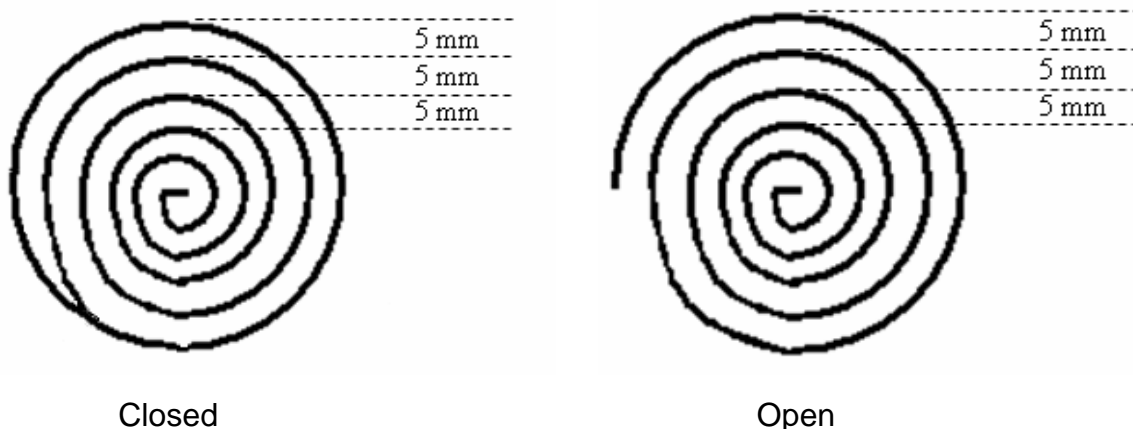

An open or closed option is also available for this function. Selecting the Closed option will make a whole circle first before making the spiral. Selecting the Open option will make the spiral without closing the outer circle.

### 5.1.12.7 Call Subroutine

A subroutine is a set of instructions that are located after the End Program instruction.

**Call Subroutine** causes the machine to jump to a specified memory address and execute the instructions found there using coordinates specified at the **Call Subroutine** instruction. When the *End Program* instruction for the subroutine is reached, program execution will continue at the address immediately after the **Call Subroutine** instruction.

The **Call Subroutine** function is most useful to repeat a pattern anywhere on the work-piece, as opposed to the *Step & Repeat* function where the pattern must be repeated in straight lines, at fixed distances from each other.

The following example illustrates the use of the *Call Subroutine* instruction. An explanation follows.

Address	Instruction
1	Line Speed = 20
2	Call Subroutine (X1,Y1,Z1) address 7
3	Call Subroutine (X2,Y2,Z2) address 7
4	Call Subroutine (X3,Y3,Z3) address 7
5	Call Subroutine (X4,Y4,Z4) address 7
6	End Program
7	Line Start (Xs,Ys,Zs)
8	Line Passing (Xp,Yp,Zp)
9	Line End (Xe,Ye,Ze)
10	End Program

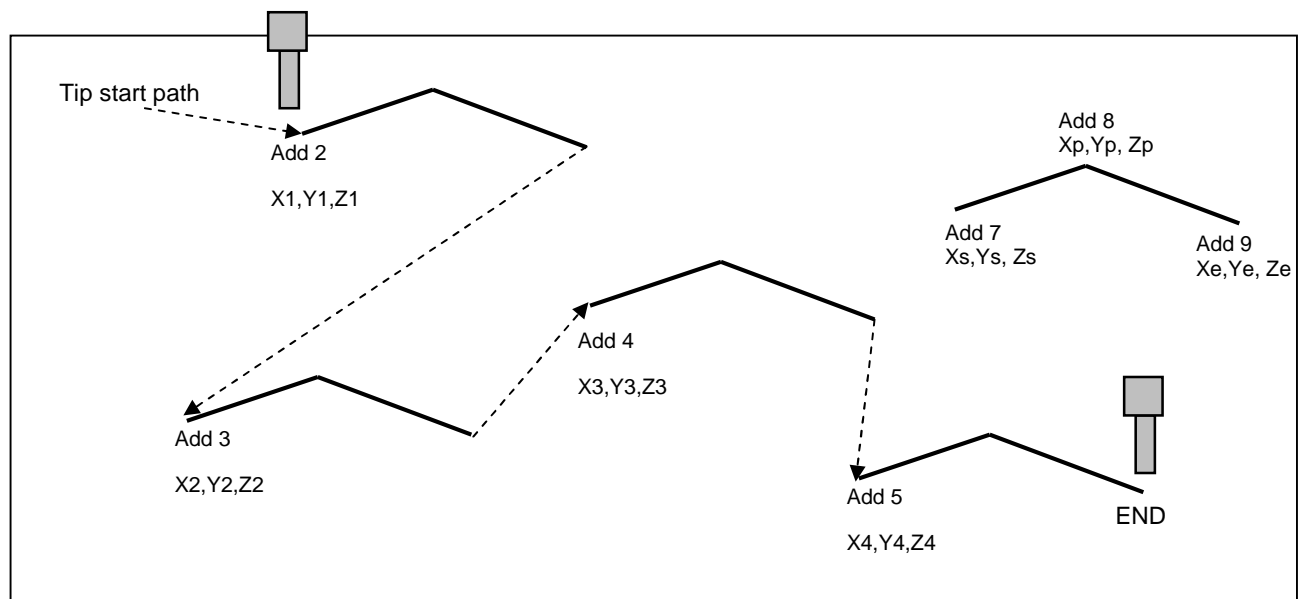

Addresses 7, 8 and 9 comprise the subroutine that will be executed whenever it is called within the main program. The coordinates in the body of the subroutine (Xs,Ys,Zs, Xp,Yp,Zp Xe,Ye,Ze) are not important; *the critical information is the relative position to each other*. The actual work will be performed on the coordinates in the main body of the program.

Before using the **Call Subroutine** instruction, the tip must be jogged to the first point where the user wants the work to occur. This point must correspond to the *relative* first point defined in the subroutine.

---

### 5.1.13 Call Program

---

**Call Program** will jump to the specified program number and execute the program data in the destination program until the End Program command is reached. When the destination program is executed, the robot will return to the calling program.

---

### 5.1.14 Set I/O

---

**Set I/O** registers an instruction, which either sets the value of an output signal or checks the status of an input signal.

When the Set I/O function is registered, the user is prompted to select *1. Input* or *2. Output*.

If **1. Input** is selected; the user can enter the input **Port** (input # 1 – 8), the input **Status** (1/0) and the address to **GOTO** if that input status occurs. The input status is (0) when the input pin is connected to ground. The input status is (1) if the input pin is disconnected.

If **2. Output** is selected, the user can enter the output **Port** (output # 0 – 8), and whether the output should be turned **ON** or **OFF**.

Please see **SECTION 6: Sample Programs** for an example of the Set I/O instruction.

---

### **5.1.15**      ***Wait Point***

---

Registers a Wait Point at the current X, Y, Z location. When executed, the tip will move to that location and wait for the specified period of time.

Wait Point can only be implemented on RUN Mode.

---

### **5.1.16**      ***Stop Point***

---

Registers a Stop Point at the current X, Y, and Z location. When executed, the tip will move to that location and wait until the start button is pressed.

---

### **5.1.17**      ***Home Point***

---

Registers an instruction to 'HOME' all axes, sending them to the home position. It works like a "Move" command.

It works like an "End Program" function when registered at the end of the program. After program completion, the dispensing tip moves to the home position. If used in the body of the program, the tip is moved to the home position and the next instruction is executed.

This function uses the *Home Position Setup* coordinates (under F4 Menu) if a new home position is made. Otherwise, it uses the default home position (X=0, Y=0, Z=0). See the F4 Menu for instructions on changing the location of the home position.

---

### **5.1.18**      ***Loop Address***

---

Registers an instruction, which will execute a group of instructions a user-specified number of times.

When the ***Loop Address*** instruction is registered, the display will prompt for an ***Address*** and ***Count***.

***Address*** is the memory address to jump to from the current address. This address must be less than the current memory address.

***Count*** is the number of times to execute the loop.



---

### **5.1.19**     *Dummy Point*

---

Registers the current XYZ location as a Dummy point. The tip will simply pass through this point. A dummy point is useful for avoiding obstacles on the work piece.

---

### **5.1.20**     *Initialize*

---

Registers an Initialize point. Causes the robot to perform a mechanical initialization. The tip will home to position (0, 0, 0) and the robot will re-find the home position using the home position sensors.

---

### **5.1.21**     *Label*

---

Registers a label that can be used as a reference when used with the GOTO, Loop address, Set I/O, Step & repeat X, Step & repeat Y and Call Subroutine commands.

*Label* can be used instead of Address number. A maximum of 64 labels is permitted per program; each label can have up to 8 characters.

---

### **5.1.22**     *Display Counter*

---

The *Display Counter* instruction shows a counter at the bottom of the teach pendant screen while a program is running. Every time this instruction is executed, the counter increases by one and is shown again on the screen. The counter begins at one (1).

---

### **5.1.23**     *Loop Counter*

---

The *Loop Counter* either clears or keeps the current tally of the counter when an I/O signal is received. The tally is cumulatively added to the current count on the display counter.

---

### **5.1.24     *Needle Adjustment***

---

This command used to perform needle calibration before dispensing by every cycle. Suggest putting *Needle Adjustment* command at beginning of program.

To achieve this feature, you need “*Teach Needle Adjustment*” first, Please refer **5.4.24**.

There is another way to perform Needle calibration without putting the *Needle Adjustment* command into program. In **RUN** mode, Press **F4** Key, Robot will perform Needle calibration manually.

**Note: Robot only stores the latest needle calibration data in memory.**

---

### **5.1.25     *Needle Adjustment Counter***

---

Set up needle adjustment counter numbers. While the number reached, system performs needle calibration.

For example, Set counter number as 10. Robot will perform needle calibration by every 10 dispense finished.

This feature should be work with Needle adjustment command.

### 5.1.26 Arc Dispense Setup

Addr.	Command	Notes
0006	Line Start (10, 10, 35)	Registers a Line Start point at X: 10 mm, Y: 10 mm, Z: 35 mm
0007	Line Passing (10, 20, 35)	Registers a Line Passing point at X: 10 mm, Y: 20 mm, Z: 35 mm
0008	Arc (5, 25, 35)	Registers an Arc point at X: 5 mm, Y: 25 mm, Z: 35 mm
0009	Arc Dispense Time (1 sec)	Pre-shut off valve 1 sec before Robot move to arc end point.
0010	End Program	

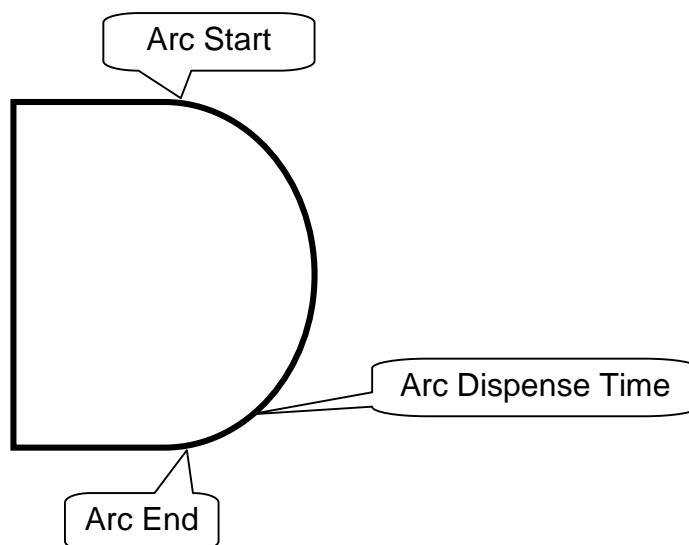

## 5.2 F2 Menu (F2 Key)

### 5.2.1 Group Edit

Group Edit is a powerful utility, which allows several different functions to be applied to a user-defined group of addresses. These functions include copy, delete, move, multiply line speed, multiply dispense times, apply X Offset, apply Y Offset, and apply Z Offset.

#### 5.2.1.1 Copy

For example, to use group edit to copy addresses 1 – 10 in the current program to memory address 11 - 20:–

	<i>Instruction</i>	<i>Display Shows</i>
1	Press the <b>F2</b> key, then <b>1</b> to select <i>Group Edit</i> . The display will prompt the user to enter the starting memory address of the group to edit ( <b>From</b> ) and the ending number of the group to edit ( <b>To</b> ).	GROUP EDIT FROM: 1 TO: 1 (1 <-> 4000) w+: All            w-: End
2	Type <b>1</b> then press <b>ENTER</b> to register 1 in <i>From</i> . Type <b>10</b> then press <b>ENTER</b> to register 10 in <i>To</i> .	GROUP EDIT ADDR: 1-10 -----y    5.Dispense Time 2.Delete    6.Offset 3.Move      7.Offset (R.E) 4.Line Speed Select:
3	The <i>Group Edit</i> menu will then appear, allowing the user to select an operation to be applied to the range of points. Press <b>1</b> to select <i>Copy</i> . Then press <b>ENTER</b> .	GROUP COPY -----E 1-10 Destination:
4	The display will prompt the user to type the destination memory address where the data will be copied. Press the Clear key to erase the old value, then type <b>11</b> and press <b>ENTER</b> to select destination memory address number 21.	GROUP COPY SOURCE 1-10 Destination: 11 1.Yes.No <b>3.</b> Select:
5	The display will now prompt the user to confirm the copy. Press <b>1</b> and then press <b>ENTER</b> to select <i>Yes</i> and perform the copy.	

### 5.2.1.2 Delete

To use group edit to delete addresses 10 – 25 in the current program:

	<i>Instruction</i>	<i>Display Shows</i>
1	<p>Press the <b>F2</b> key, then <b>1</b> to select <i>Group Edit</i>.</p> <p>The display will prompt the user to enter the starting memory address of the group to edit (<b>From</b>) and the ending number of the group to edit (<b>To</b>).</p>	<pre>GROUP EDIT FROM: 1   TO: 1 (1 &lt;-&gt; 4000) w+: All      w-: End</pre>
2	<p>Type <b>10</b> then press <b>ENTER</b> to register 15 in <i>From</i>.</p> <p>Type <b>25</b> then press <b>ENTER</b> to register 25 in <i>To</i>.</p>	<pre>GROUP EDIT ADDR: 10-25 -----s 1.Copy    5.Dispense Time 2.Delete  6.Offset 3.Move    7.Offset (R.E) 4.Line Speed Select:</pre>
3	<p>The <i>Group Edit</i> menu will then appear, allowing the user to select an operation to be applied to the range of points.</p> <p>Press <b>2</b> to select <i>Delete</i>. Then press <b>ENTER</b></p>	<pre>GROUP DELETE ADDR: 10-25 -----s 2. No Select:</pre>
4	<p>The display will now prompt the user to confirm the deletion.</p> <p>Press <b>1</b> and then press <b>ENTER</b> to select Yes and delete the data.</p>	

### 5.2.1.3 Move

To use group edit to move addresses 10 – 20 in the current program to memory addresses 50 – 60:

	<i>Instruction</i>	<i>Display Shows</i>
1	<p>Press the <b>F2</b> key, then <b>1</b> to select <i>Group Edit</i>.</p> <p>The display will prompt the user to enter the starting memory address of the group to edit (<b>From</b>) and the ending number of the group to edit (<b>To</b>).</p>	<pre>GROUP EDIT FROM: 1    TO: 1 (1 &lt;-&gt; 4000) w+: All      w-: End</pre>
2	<p>Type <b>10</b> then press <b>ENTER</b> to register 10 in <i>From</i>.</p> <p>Type <b>20</b> then press <b>ENTER</b> to register 20 in <i>To</i>.</p>	<pre>GROUP EDIT ADDR: 10-20 -----y   5.Dispense Time 2.Delete  6.Offset 3.Move    7.Offset (R.E) 4.Line Speed Select:</pre>
3	<p>The <i>Group Edit</i> menu will then appear, allowing the user to select an operation to be applied to the range of points.</p> <p>Press <b>3</b> to select <i>Move</i>. Then press <b>ENTER</b></p>	<pre>GROUP MOVE -----E 10-20 Destination:</pre>
4	<p>The display will prompt the user to type the destination memory address where the data will be moved.</p> <p>Press the <b>Clear</b> key to erase the old value, then type <b>50</b> and press <b>ENTER</b> to select destination memory address number 50.</p>	<pre>GROUP MOVE SOURCE 10-20 Destination: 50 1.Yes.No <b>3.</b> Select:</pre>
5	<p>The display will now prompt the user to confirm the move. Press <b>1</b> and then press <b>ENTER</b> to select Yes and move the data.</p>	

### 5.2.1.4 Line SP (Line Speed)

To use group edit to increase all of the line speed commands in memory address range 1 – 200 by 20 %:

	<i>Instruction</i>	<i>Display Shows</i>
1	<p>Press the <b>F2</b> key, then <b>1</b> to select <i>Group Edit</i>.</p> <p>The display will prompt the user to enter the starting memory address of the group to edit (<b>From</b>) and the ending number of the group to edit (<b>To</b>).</p>	<pre>GROUP EDIT FROM: 1   TO: 1 (1 &lt;-&gt; 4000) w+: All      w-: End</pre>
2	<p>Type <b>1</b> then press <b>ENTER</b> to register 1 in <i>From</i>.</p> <p>Type <b>200</b> then press <b>ENTER</b> to register 200 in <i>To</i>.</p>	<pre>GROUP EDIT ADDR: 1-200 -----y   5.Dispense Time 2.Delete  6.Offset 3.Move    7.Offset (R.E) 4.Line Speed Select:</pre>
3	<p>The <i>Group Edit</i> menu will then appear, allowing the user to select an operation to be applied to the range of points.</p> <p>Press <b>4</b> to select <i>Line Speed</i>. Then press <b>ENTER</b>.</p>	<pre>GROUP LINE SPEED ADDR: 1-200 -----ple Value:</pre>
4	<p>The display will prompt the user to type the Multiple Value to be applied to the line speeds.</p> <p>For example, a value of 1.2 will increase all speeds by 20%. A value of 0.8 will decrease all speeds by 20%.</p> <p>Type <b>1.2</b> and press <b>ENTER</b> to select a multiplier of 1.2.</p>	<pre>GROUP LINE SPEED ADDR: 1-200 -----ple Value: 1.2 1.Yes 2.No Select:</pre>
5	<p>The display will now prompt the user to confirm the change. Press <b>1</b> to select Yes. Then press <b>ENTER</b></p> <p>All of the line speed instructions in the select range of points will now be multiplied by 1.2.</p>	

### 5.2.1.5 Dispense Time

To use group edit to increase all of the dispensing times (Point Dispense Setup) in memory address range 1 – 200 by 15%:

	<i>Instruction</i>	<i>Display Shows</i>
1	<p>Press the <b>F2</b> key, then <b>1</b> to select <i>Group Edit</i>.</p> <p>The display will prompt the user to enter the starting memory address of the group to edit (<b>From</b>) and the ending number of the group to edit (<b>To</b>).</p>	<pre>GROUP EDIT FROM: 1   TO: 1 (1 &lt;-&gt; 4000) w+: All      w-: End</pre>
2	<p>Type <b>1</b> then press <b>ENTER</b> to register 1 in <i>From</i>.</p> <p>Type <b>200</b> then press <b>ENTER</b> to register 200 in <i>To</i>.</p>	<pre>GROUP EDIT ADDR: 1-200 -----y   5.Dispense Time 2.Delete  6.Offset 3.Move    7.Offset (R.E) 4.Line Speed Select:</pre>
3	<p>The <i>Group Edit</i> menu will then appear, allowing the user to select an operation to be applied to the range of points.</p> <p>Press <b>5</b> to select <i>Dispense Time</i>. Then press <b>ENTER</b>.</p>	<pre>GROUP DISPENSE TIME ADDR: 1-200 -----ple Value:</pre>
4	<p>The display will prompt the user to type the Multiple Value to be applied to the dispense times.</p> <p>For example, a value of 1.15 will increase all dispense times by 15%. A value of 0.85 will decrease all dispense times by 15%.</p> <p>Type <b>1.15</b> and press <b>ENTER</b> to select a multiplier of 1.15.</p>	<pre>GROUP DISPENSE TIME ADDR: 1-200 -----ple Value: 1.15 1.Yes 2.No Select:</pre>
5	<p>The display will now prompt the user to confirm the change. Press <b>1</b> to select Yes. Then press <b>ENTER</b>.</p> <p>All of the Point Dispense Setup instructions in the select range of points will now be multiplied by 1.15.</p>	



### 5.2.1.6 Offset

The Offset function allows all XYZ locations in a program to be shifted in the X, Y, or Z-axis by a user-defined distance.

To use group edit to add 15 mm to all X-axis values in memory address range 1 – 200:

	<i>Instruction</i>	<i>Display Shows</i>
1	<p>Press the <b>F2</b> key, then <b>1</b> to select <i>Group Edit</i>.</p> <p>The display will prompt the user to enter the starting memory address of the group to edit (<b>From</b>) and the ending number of the group to edit (<b>To</b>).</p>	<pre>GROUP EDIT FROM: 1    TO: 1 (1 &lt;-&gt; 4000) w+: All      w-: End</pre>
2	<p>Type <b>1</b> then press <b>ENTER</b> to register 1 in <i>From</i>.</p> <p>Type <b>200</b> then press <b>ENTER</b> to register 200 in <i>To</i>.</p>	<pre>GROUP EDIT ADDR:1-200 ----- 1.Copy      5.Dispense Time 2.Delete    6. Offset 3.Move      7.Offset (R.E) 4.Line Speed Select:</pre>
3	<p>The <i>Group Edit</i> menu will then appear, allowing the user to select an operation to be applied to the range of points.</p> <p>Press <b>6</b> to select <i>Offset</i>. Then press <b>ENTER</b>.</p>	<pre>GROUP OFFSET ADDR: 1-200 ----- X Offset: 0 Y Offset: 0 Z Offset: 0 Unit: mm</pre>
4	<p>The display will prompt the user to type the X, Y, and Z offset amounts to be added to all points in address range 1 – 200.</p> <p>Type <b>15</b> and press <b>ENTER</b> to add 15 mm to the X-axis values. Press <b>ENTER</b> two more times to leave the Y and Z offsets at zero.</p>	<pre>GROUP OFFSET ADDR: 1-200 ----- X Offset: 15 Y Offset: 0 Z Offset: 0 1.Yes  2.No Select:</pre>
5	<p>The display will now prompt the user to confirm the change. Press <b>1</b> to select Yes. Then press <b>ENTER</b>.</p> <p>15 mm will be added to all of the X-axis values in the selected range.</p>	

---

### **5.2.1.7    *Offset (R.E)***

---

This Offset (R.E) function allows to be corrected automatically the offset problems which can appear when changing the tip, the barrel and/or the item to be dispensed on.

The steps to be followed are similar with those shown under the function 2.1.6. Offset.

(To be seen also: Section 5: 5.9. Adjust Position Setup).

## 5.2.2 Expand Step & Repeat

Expand Step & Repeat<sup>1</sup> will expand a step and repeat instruction to the actual data it represents. For example, if the following program was created:

**Before:**

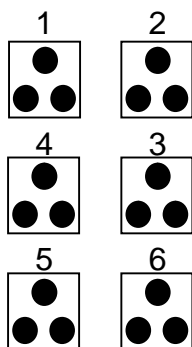

Address	Instruction
1	Dispense End Setup
2	Z Clearance
3	Point Dispense Setup
4	Dispense Point
5	Dispense Point
6	Dispense Point
7	Step & Repeat X, Addr=4
8	End Program

The original program occupies 8 memory addresses.

If the user brings memory address number 7 into the display and then selects **F2 Menu (F2 key)**, **Expand Step & Repeat**, address 7 will be expanded into the 15 points which it represents, bringing the total number of memory addresses used to 21 (plus the End Program instruction at address 22).

**After:**

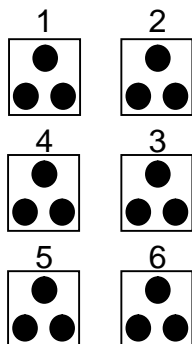

Address	Instruction
1	Dispense End Setup
2	Z Clearance
3	Point Dispense Setup
4	Dispense Point
5	Dispense Point
6	Dispense Point
7	Dispense Point
8	Dispense Point
9	Dispense Point
.	.
.	.
.	.
21	Dispense Point
22	End Program

<sup>1</sup> The Expand Step & Repeat function is useful in situations where the user must edit selected elements in a Step & Repeat group, although an expanded Step & Repeat instruction will occupy more memory space than an unexpanded instruction.

### 5.2.3 Program Name

*Program Name* allows the user to register a name for the current program. If a program name is registered, it will appear on the display when that program is selected in Run mode.

### 5.2.4 Z-axis Limit (mm)

Z-axis Limit allows the user to limit the range of the Z-axis.

Use the **Z↑** and **Z↓** keys to bring the Z-axis to the lowest point the Z-axis should be allowed to travel (the highest Z-axis numeric value), then select **F2 MENU (F2 KEY), 4. Z-axis Limit. (mm)**

The Z-axis range of motion will be limited to the current value.

### 5.2.5 Initial Output Port

*Initial Output Port* sets the ON/OFF status of the output signals at the start of each program cycle.

*Initial Output Port value* is the decimal representation of an 8 binary bit values controlling the 8 output signals.

For example,

Decimal Value	Output Status (X = on, blank = OFF)							
	#1	#2	#3	#4	#5	#6	#7	#8
0								
1	X							
2		X						
4			X					
8				X				
16					X			
32						X		
64							X	
128								X

---

## 5.2.6 Utility Menu

---

The Utility menu contains several sub-menus, detail information please refer below.

---

### 5.2.6.1 Program

---

Open the program utility menu. The Program Utility menu includes four options:

<b>1. Backup</b>	Creates a backup of the current program in reserved backup location on the memory card. A separate backup location is reserved for each program number.
<b>2. Restore</b>	Restores program data backed up with 1. Backup above. The current program number data is restored.
<b>3. Clear</b>	Erases data in the current program number.
<b>4. Copy</b>	Copies the current program number to a different program number.

---

### 5.2.6.2 Memory

---

Opens the Memory utility menu. **THE MASTER PASSWORD is 777.**

<b>1. Backup</b>	Creates a backup of the entire memory contents - all program numbers. The backup is written to a reserved location on the memory card.
<b>2. Restore</b>	Restores the entire contents of the robot memory backed up with 1. Backup above.
<b>3. Clear</b>	Erases the entire contents of the robot memory. If Clear is selected, the user will be prompted for a password.

### 5.2.6.3 Teach Pendant

Open the Teach Pendant utility menu. The Teach Pendant utility menu includes three options:

<b>1. Backup</b>	Copies the current program number data to the Teach Pendant.
<b>2. Restore</b>	Restores the contents of the Teach Pendant memory into the current program number.
<b>3. Clear</b>	Clear all program which stored in Teach Pendant.

The above teach pendant utilities provide an easy method of moving program data from one robot to another.

### 5.2.6.4 Relocate Data

The Relocate Data function allows the position of a program to be corrected, including correction for X offset, Y offset and angle of rotation.

If, for example, the work piece fixture has been changed, the program position can be adjusted automatically for the new fixture.

The Relocate Data function requires two reference points for the calculations. Choose two point locations from your program, which will be used as reference points. For example, to relocate the program after a fixture change:

	<i>Instruction</i>	<i>Display Shows</i>
1	In this example, memory address 3 is the first reference point and memory address 4 is the second reference point.  Jog the tip to the new, correct position for the first reference point.	
2	Press the <b>F3</b> key, then select <b>Save Temp Point</b> to save the location. The display will prompt for the temporary point number to save.	Save temp point ----- Point (1-9):  Relocate Save To 1,2 Point

	<i>Instruction</i>	<i>Display Shows</i>
3	Press <b>1</b> to save the first location in temporary position #1. Then press <b>ENTER</b>	
4	Jog the tip to the new, correct position for the second reference point.	
5	Press the <b>F3</b> key, then select <b>Save Temp Point</b> to save the location. The display will prompt for the temporary point number to save.	Save temp point ----- Point (1-9):  Relocate Save To 1,2 Point
6	Press <b>2</b> to save the second location in temporary position #2. Then press <b>ENTER</b>	
7	Press <b>F2</b> , then <b>7. Utility Menu</b> , and select <b>Relocate Data</b> .	Relocate Data ----- 1.All Points 2.Some Points SELECT:
8	Press <b>1</b> to select <i>All Points</i> . Then press <b>ENTER</b>	Relocate All Point S1-> S2->
9	Type <b>3</b> and press <b>ENTER</b> to designate memory address number 3 as reference point 1 (temp point #1).	Relocate All Point S1->3 S2->
10	Type <b>4</b> and press <b>ENTER</b> to designate memory address number 4 as reference point 2 (temp point #2).	Relocate All Point S1->3 S2->4
11	The program location will be adjusted for X offset, Y offset and angle of rotation.	

---

### **5.2.6.5      *Lock or Unlock Program***

---

*Lock or Unlock Program* allows the user to protect a program from editing. If the program is locked, the user will not be able to change any of the program data. Unlocking the program will allow the data to be changed again.

---

### **5.2.6.6      *Password Setup***

---

*Password Setup* allows the password to be set or reset for the current program.

To set the password, select **F2 MENU (F2 KEY)**, *Utility Menu*, and ***Password Setup***. The user will be prompted for a ***NEW PASSWORD***. Type the new password and press **ENTER**.

If the password is left blank and **ENTER** is pressed, the password will be removed. After changing or resetting the password, the robot power should be turned off.

The purpose of the password is to protect the program from unauthorized editing. The user will not be allowed to enter TEACH mode unless the correct password is entered. If the password is forgotten, the master password (777) can be used to gain access to the program.

---

### **5.2.6.7      *Key Beep***

---

To set the “beep” sound on or off when pressing the key on teach pendant.

---

### **5.2.6.8      *Test Function***

---

To test the Robot Sensor, Panel Connector, Input Output signal, Teach Pendant and Motor.

---

### **5.2.6.9      *Clear Teach Pendant Data***

---

To erase all data stored inside the teach pendant.



---

## **5.3 F3 Menu (F3 Key)**

---

---

### **5.3.1 Numerical Move**

---

Allows the tip to be positioned numerically by entering a number for the X, Y and Z values.

---

### **5.3.2 Save Temp Point**

---

Save Temp Point saves the current XYZ position in a temporary memory area numbered (1 – 9). The save temp point function is also used with the Relocate Data function.

See **SECTION 5:5.2.6.4 Relocate Data**.

---

### **5.3.3 Move To Temp Point**

---

Move To Temp Point retrieves a XYZ position, which was stored with Save Temp Point.

---

### **5.3.4 Undo Program**

---

Cancel the last change to the program. Returns to the program state prior to the last change.

---

### **5.3.5 Redo Program**

---

Re-do the last change to the program, which was cancelled with Undo.

---

### 5.3.6 Debug Program

---

Runs the program in Debug mode, using the speed set in Debug Speed starting at the current point location.

---

### 5.3.7 Move To Home Position

---

*Move To Home Position* will move the tip to the home location using either the default values (X=0, Y=0, Z=0) or the user-specified location defined in the *Setup (F3 Key) → Home Position Setup* command.

This command cannot be used as a program instruction. It can be used during program editing to confirm the location of the home position.

---

### 5.3.8 System Information



---

System information will display the dispensing Software version currently installed in the robot.

---

### 5.3.9 Execute Point

---

*Execute Point* will run a selected command. Use the  &  keys to locate the command that you want to execute.

For example, if you select an address containing a circle, the Execute Point will cause the tip to move in a circular path.

---

### 5.3.10 Program Name List

---

To display all programs with program name in order by program number.

---

## 5.4 F4 Menu (F4 Key)

---

Below is a list of functions, which are found under the **F4** key. These functions are all related to the setup of dispensing parameters.

---

### 5.4.1 Line Speed

---

Registers the line speed used for all lines from the current memory address forward until another Line Speed instruction is found.

The default line speed is set at 10mm/sec.

---

### 5.4.2 Line Dispense Setup

---

When dispensing high viscosity materials, there is often a delay from the moment the dispenser is turned on until the material begins to flow. The following parameters are set under this function: Head Time, Tail Time, Node Time and Tail Length.

The **Head Time** setting is a delay time used at the start of line dispensing to prevent the tip from moving along the line path until the material is flowing. The tip will move to the start of the line, turn on the dispenser and wait for the time period specified in the *head time* setting before moving. The time value can be adjusted to ensure that the material begins flowing at the same time as the line movement begins.

At the end of dispensing, a delay is often required after the dispenser is turned off, to allow the barrel pressure to equalize, before moving to the next point location. This prevents material from being 'spilled' where it is not wanted. This time delay at the end of dispensing is called the **Tail Time**.

The **Node Time** parameter enters a wait time that only affects the **Line Passing** command. Tip will pass through line passing point and will **wait at line passing point** with the dispenser **activated** for the time specified in the **Node Time**.

Usually the material continues flowing after the dispenser is off, due to pressure built in the system. **Tail Length** automatically turns off the dispenser at a user defined distance before the end of a line, preventing excess of material to be deposited at the end of the line.

The value will be used for all lines from the current memory address forward until another **Tail Length** instruction is found.

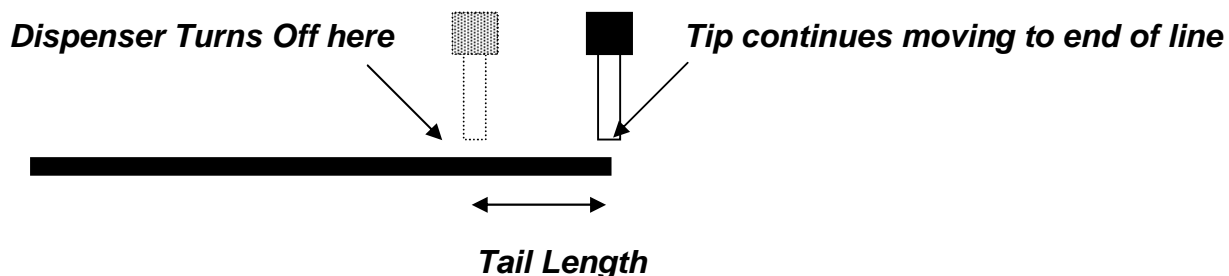

Values for the *Head Time* and *Tail Time* used when performing line dispensing are registered by pressing the **F4** key, then selecting **Line Dispense Setup**. The set values will be used by all lines from that memory address forward until new set of *Line Dispense Setup* values are found.

Please see **SECTION 6: Sample Programs** for an example of the *Line Dispense Setup* instruction.

---

### 5.4.3 Point Dispense Setup

---

Registers POINT DISPENSE SETUP values which set dispensing time and waiting time at the end of dispensing ('tail' time) for dots. The registered values will be used from the current memory address forward until another POINT DISPENSE SETUP instruction is found.

The default point dispense time is set at 0.5 seconds.

---

### 5.4.4 Dispense End Setup

---

*Dispense End Setup* allows the **L. Length**, **L. Speed** and **H. Speed** values to be registered at a memory address. These values will effect how far and how fast the tip rises after dispensing.

After dispensing a dot or line, it is often required to raise the tip a short distance at a slow speed. This allows the material to cleanly break free from the tip, without 'dragging' material where it is not wanted.

The distance and speed that the tip raises after dispensing is controlled by the **L. Length** and **L. Speed** settings.

After the tip raises the length specified by **L. Length** at the speed specified by **L. Speed**, the tip will continue rising to the **Z Clearance** height at the speed specified by **H. Speed**.

The purpose of specifying a Z Clearance height is to allow the tip to raise high enough to clear any obstacles it may encounter on the way to the next point.

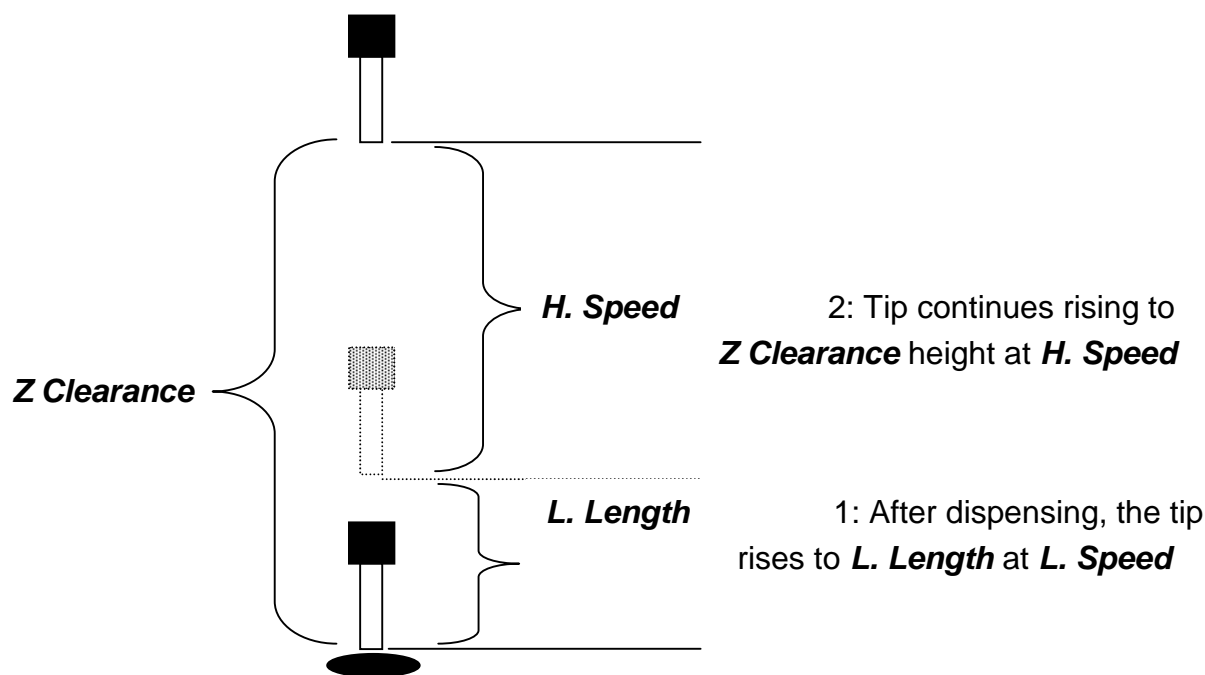

Values for **H. Speed**, **L. Speed** and **L. Length** are registered with the **Dispense End Setup** function by pressing the **F4** key, then choosing **Dispense End Setup**.

Once **Dispense End Setup** values have been registered at a memory address, all points after that memory address will use the values specified. If **Dispense End Setup** values are registered again, at a higher memory address, all points from that memory address forward will use the new values.

Please see **SECTION 6: Sample Programs** for an example of the **Dispense End Setup** instruction.

### 5.4.5 Z Clearance

---

The purpose of the Z Clearance function is to cause the tip to raise high enough to clear all obstacles as it moves from one point to another. If there are no obstacles between any of the program points, a small Z Clearance value, such as 5 mm, can be used to minimize the program cycle time.

Values for the *Z Clearance* are registered by pressing the **F4** key, then choosing **Z Clearance**. The *Z Clearance* value will be used by all points from that memory address forward until another *Z Clearance* value is found. Normally, a Z clearance instruction should be registered in the beginning of a program, at one of the first memory addresses.

The Z Clearance value may be specified as a relative value or an absolute value. When specified as a relative value, it is the distance to rise relative to the taught point location. When it is specified as an absolute value, it is a distance from the Z-axis zero position, where the tip will rise to, regardless of the Z-axis value of the taught point location. For example:

#### Z Clearance = 10 mm RELATIVE:

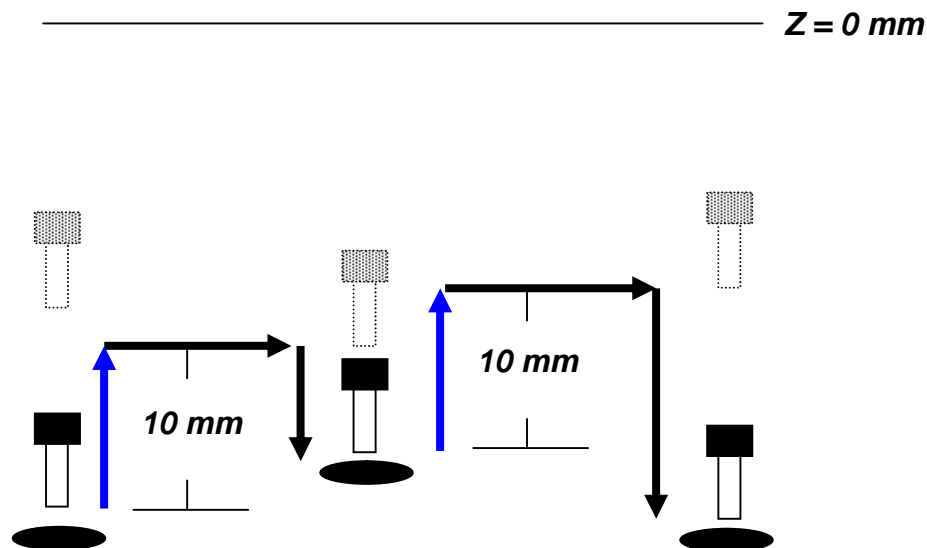

**Z Clearance = 10 mm ABSOLUTE:**

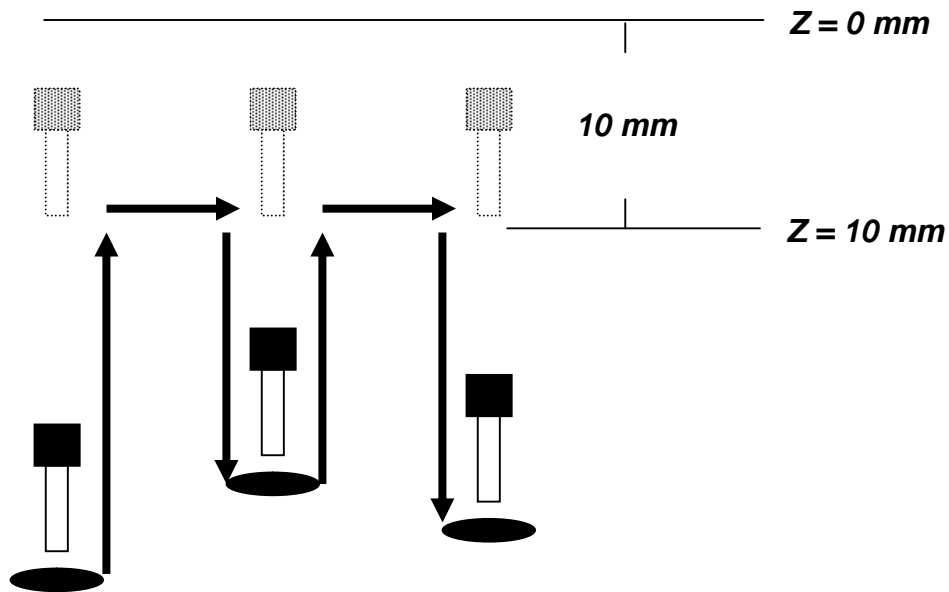

Please see **SECTION 6: Sample Programs** for an example of the *Z Clearance* instruction.

---

### **5.4.6 X/Y Move Speed**

---

*X/Y Move Speed* sets default X and Y-axis movement speed as the tip moves between figures in a program, such as from one dispense point to another or from the end of line dispensing to the next start of line dispensing.

---

### **5.4.7 Z Move Speed**

---

*Z Move Speed* sets default Z-axis movement speed as the tip moves between figures in a program, such as from one dispense point to another or from the end of line dispensing to the next start of line dispensing.

---

### **5.4.8 Home Position Setup**

---

*Home Position Setup* allows the user to change the location of the program home position. The home position is the location where the tip will move to at the end of a program cycle if the “End Program” or “Home Point” instruction is registered. The default home position is (X=0, Y=0, Z=0).

To change the home position, jog the tip to the desired location for the new home position, then press **F4** → **Home Position Setup**.

**NOTE:** When executing a program in TEACH MODE, the robot will move to the mechanical home position (X=0, Y=0, Z=0) at the start of every program cycle. When executing a program in RUN MODE, the robot will move to the home position set under **F4 Menu (F4 KEY)** → *Home Position Setup*.



### 5.4.9 Adjust Position Setup

When the dispensing barrel or tip is removed and replaced, the new tip is often in a slightly different XYZ position than the old tip was. The robots have a software utility to adjust a program's origin, thereby correcting the tip's offset problem.

A reference point should be chosen someplace on the work piece fixture or on the work piece itself. The reference point must be registered in the program data. This only needs to be done one time, such as when the program is originally created.

	<i>Instruction</i>	<i>Display Shows</i>
1	Jog the tip to the reference point (i.e. X=10, Y=20, Z=30)  Or if the reference point is an existing point in your program, press the <b>MOVE</b> key to bring the tip to that XYZ location.	
2	Press the <b>F4</b> key, and go to page two  P.S. or using the key 	[SETUP] 2/3 1 Home Position Setup 2 Adjust Position Setup : : 7 Acceleration
	Press 2 to Select <b>Adjust Position Setup</b> . The current point will be saved automatically. (The point will not be registered at any address in the program, but it will be saved as a global variable for the current program)	Set Adjust Position ----- X: 10 Y: 20 Z: 30

When the tip/barrel is changed, use the following procedure to adjust the program's origin for the new tip location:

	<i>Instruction</i>	<i>Display Shows</i>
	Switch the robot to <b>RUN mode</b> (the main unit mode switch is in the RUN position)	Counter:0  +-----+   START/HOME   +-----+
1	Press the <b>F1</b> key.	[Run Menu] 1/1 1. Reset Counter 2. Adjust Origin 3. Relocate Data 4. Cycle Counter
2	Press <b>2</b> to select <i>Adjust Origin</i> .	[MESSAGE BOX] -----  Press [ENTER] Adjust Position  -----
3	Press the <b>Enter</b> key. The tip will move to the reference point previously saved (X=10, Y=20, Z=30).  If the new tip's location is slightly different than the last tip's location, you should see that the tip is not exactly at the reference point	[MESSAGE BOX] -----  Move TIP  ----- X10 Y20 Z30
4	Jog the tip to the correct location for the reference point.  When the location is correct, press <b>ENTER</b> .  All the coordinates in the current program will be offset to compensate the tip offset	[MACHINE HOME]  +-----+   START/HOME   +-----+

### 5.4.10 *Retract Setup*

---

The *Retract* function gives the programmer a high level of tip control at the end of line dispensing. This is useful when dispensing high viscosity or 'stringy' materials as it will lay the material's tail down on the dispensed bead.

There are five types of the *Retract Setup* functions: 0 (Normal), 1 (Back), 2 (Square Back), 3 (Forward) and 4 (Square Forward).

---

**#0: RETRACT (NORMAL)**

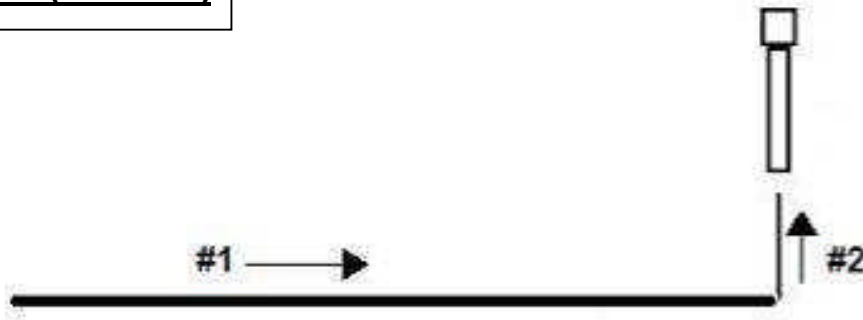

**#1: RETRACT (BACK)**

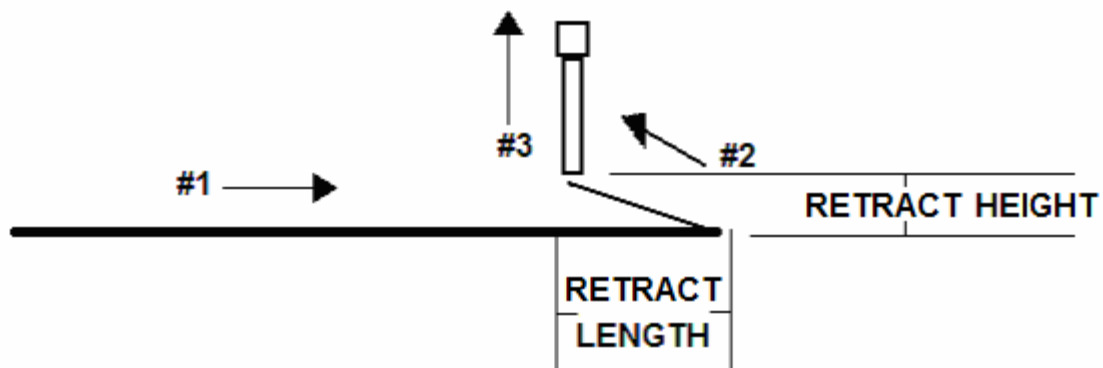

**#2: RETRACT (SQUARE BACK)**

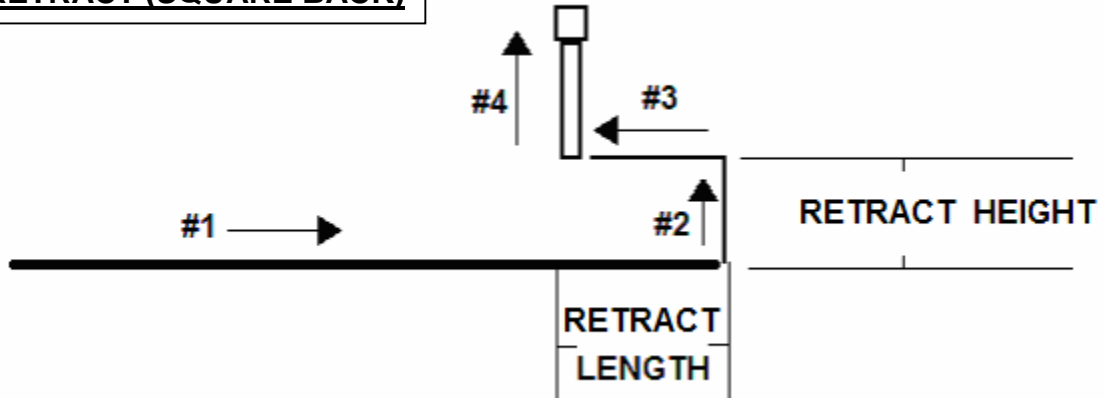

**#3: RETRACT (FORWARD)**

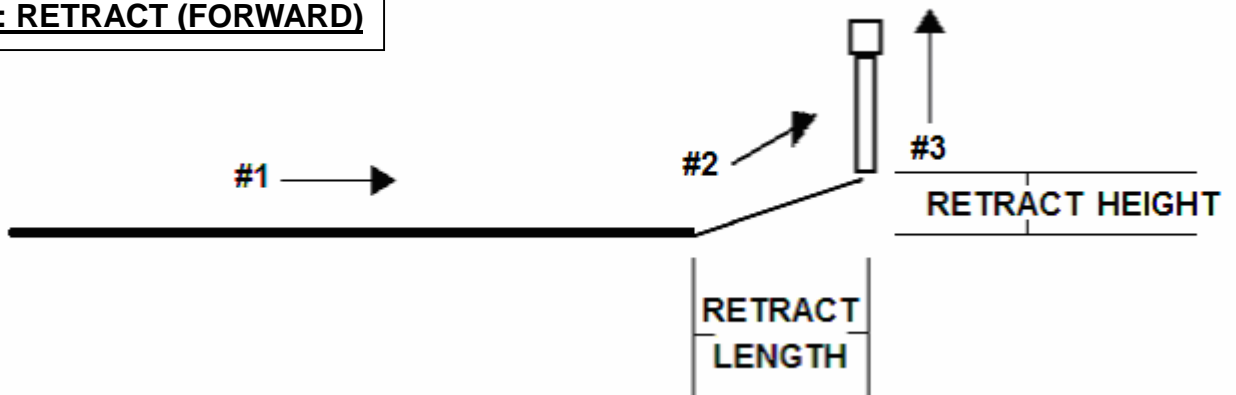

**#4: RETRACT (SQUARE FORWARD)**

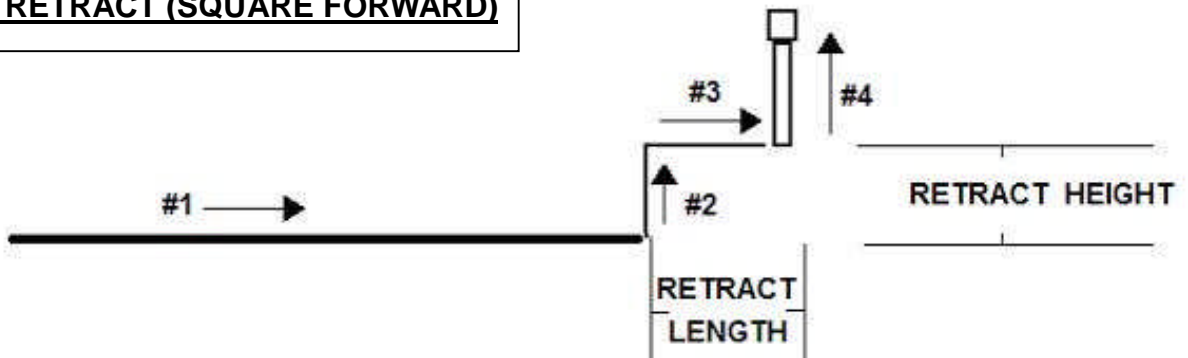

The retract function requires the following parameters:

**RETRACT LENGTH:** the distance to travel away from the line end point

**RETRACT HEIGHT:** the distance to rise as the tip moves away from the line end (must be smaller than the value of Z clearance in that point).

**RETRACT SPEED:** the speed at which the tip moves along the retract path

**RETRACT TYPE:**

0. NORMAL
1. BACK
2. SQUARE BACK
3. FORWARD
4. SQUARE FORWARD

Retract values will be used for all lines from the current memory address forward until another Retract instruction is found or the function is canceled.

---

### **5.4.11 Quickstep**

---

Causes the robot to move very fast from one point to another reducing the time of the dispensing cycle.

---

### 5.4.12 *Auto Purge Setup*

---

After the end of a program, the tip will go to the home position and material will be purged in a continuous loop according to the parameters registered in the Auto Purge Setup command.

This command is very useful for two part materials that have a very short pot life.

For example, if a Wait Time of 5s and a Purge Time of 2s is registered in the Auto Purge Setup, the following chart shows the Purge pattern.

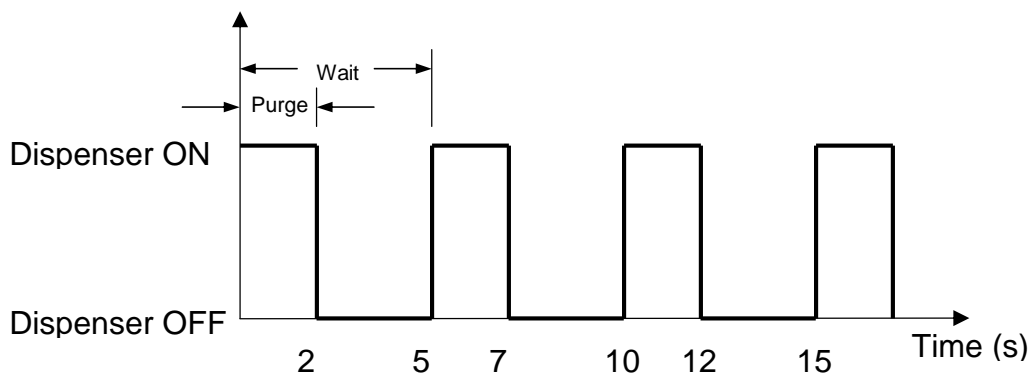

---

### 5.4.13 *ESTOP Output Status*

---

After receiving the emergency stop signal, the robot can set the status of all the outputs as:

- INITIAL: The status (On/Off) of the outputs is set as the status set by the **Initial IO** command. See Initial Output Port (Section 5: 3.5)
- KEEP OUTPUT STATUS: The status (On/Off) of the outputs is left as it was before the emergency signal.

---

#### **5.4.14      *Acceleration***

---

Controls the acceleration of each axis. The value entered in this setting is a robot parameter and its exact relation to the robot's acceleration is beyond the scope of this manual.

In general, the value of the acceleration parameter is inversely related to the robot's acceleration. A small value will result in a high acceleration and vice versa. Very small values can make the motors slip and can cause the driver cards to over heat.

The default value is 25 for all the axes and values lower than 15 are not recommended.

---

#### **5.4.15      *Pause Status***

---

*Pause Status* sets the position to which the tip will move after pressing the Start button.

There are two options:

- Home position: The tip will move to the home position.
- Stand: The tip will stay at the position where the Start button was pressed.

---

#### **5.4.16      *Language***

---

Allow end user selected operating language either by English or Chinese.

---

#### **5.4.17      *Jog Speed***

---

The Jog Speed setting allows the user to select the jog speed for programming in Teach mode. The Jog speed can be set to Low, Middle or High speed.

The default value is **2. Middle**.

---

#### **5.4.18      *Debug Speed***

---

Debug Speed allows the debug speed to be set. This speed is the speed at which the tip will move when running in Debug mode.

### 5.4.19 *Adjust Origin*

Allows the position of a program to be corrected using the reference points. Corrects: X offset, Y offset.

Please refer **5.4.9 Adjust Position Setup**

### 5.4.20 *Quickstep Path*

To set up the move up shape of Z-axis. “Triangle Shape” or “Normal Shape”  
Need to use with function “Quickstep”.

### 5.4.21 *USB Up/Down Load*

To use this function, you need use the USB memory stick which comes with Henkel Robot system, or you need a USB memory stick which meet below requirement.



- A. Capacity lower than 2G bytes.
- B. Format as FAT.

*Note: All downloaded programs are saved in root folder of the memory stick, and programs which need to be uploading to Robot also need to be stored in root folder.*

#### **Upload program to USB memory stick**





	<i>Instruction</i>	<i>Display Shows</i>
1	Plug in USB Memory Stick before turning machine power on.	
2	F4 MENU → PAGE 3 →7. USB Up/Down Load	1. Up Load To USB. 2. Down Load From USB  Select :
3	Select 1, go to upload program menu.  ALL Data: All of the programs in the robot will copy to USB.  Part Data: The program which you select will copy to USB.	1.ALL Data 2.Part Data  Select :



	<i>Instruction</i>	<i>Display Shows</i>
4	<p>If select 1, all programs on Robot will be upload to USB automatically.</p> <p>If select 2,</p> <p>Then press   to select the program which you want to upload to USB. Press  to execute the selection.</p> <p>The program numbers will show on display if you ever switch to the program before.</p> <p>The program name will show on display if you have named.</p>	<p>[Up Load]</p> <p>1. 00 : No Name</p> <p>2. 07 : No Name</p> <p>3. 16 : Jean program</p>

**Download program from USB to Robot**

	<i>Instruction</i>	<i>Display Shows</i>
1	Plug in USB Memory Stick before turning machine power on.	
2	F4 MENU → PAGE 3 →7. USB Up/Down Load	<p>1. Up Load To USB.</p> <p>2. Down Load From USB</p> <p>Select :</p>
3	<p>Select 2, go to down load program menu.</p> <p>ALL Data: All of the programs in the USB will copy to Robot.</p> <p>Part Data: The program which you select will copy to Robot.</p>	<p>1.ALL Data</p> <p>2.Part Data</p> <p>Select :</p>

	<i>Instruction</i>	<i>Display Shows</i>
4	<p>If select 1, all programs on USB will be download to Robot automatically.</p> <p>If select 2,</p> <p>Then press   to select the program which you want to download to Robot. Press  to execute the selection.</p>	<p>[Down Load]</p> <p>1. 00 : No Name</p> <p>2. 09 : No Name</p> <p>3. 16 : Jean program</p>
	<p>If select program# 16, Press  to confirm, or press  to cancel.</p>	<p>[Message Box]</p> <p>-----</p> <p>Copy Program 16 From USB?</p> <p>-----</p> <p>[W+] Yes      [W-] No</p>

### **5.4.22 Circle Delay Time**

Setup Delay time if set over angle in circle command. Dispenser will expand dispensing time.

### **5.4.23 Initialize Setup**

Allow machine to performing HOMING by each of cycle. To setup this feature, go to Initialize Setup menu, and then select ENABLE.

**5.4.24 Teach Needle Adjustment**

**Overview of the Needle Adjustment Mechanism**

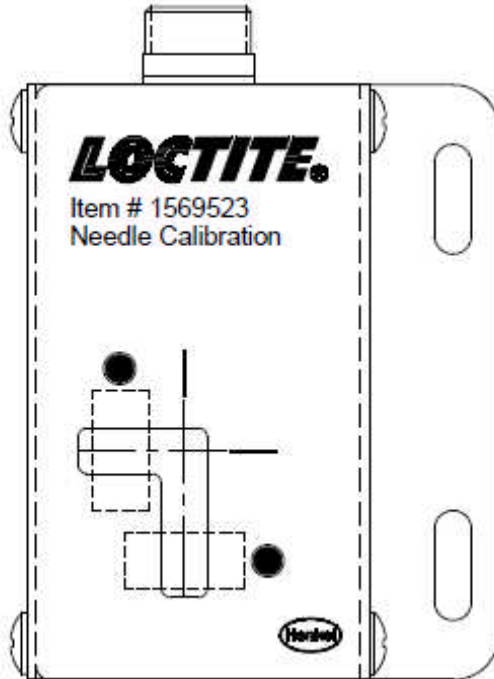

	<i>Instruction</i>	<i>Display Shows</i>
1	F4 Menu →Page 4 →Teach needle adjustment.	[MESSAGE BOX] ----- Press [ENTER] Adjust Position ----- -
2	Press ENTER.	[MESSAGE BOX] ----- Move Tip -----

	<i>Instruction</i>	<i>Display Shows</i>
3	Jog the needle tip to the cross place, lower tip inside kit approximately 2~3 mm.  Press ENTER.  Robot will calibration X,Y,Z position automatically.	[ MACHINE HOME ]  +-----+ START/HOME +-----+
4	Press Start/Home when calibration completed.	
5	Press [W-] then try to lower needle tip if you find this error information.	[MESSAGE BOX] -----  Adjust Sensor Error!!  -----  [W+] Stop      [W-] Pass

### **5.4.25 Teach Needle Adjustment Setup**

	<i>Instruction</i>	<i>Display Shows</i>
	F4 Menu →Page 4 →Needle adjustment Setup	[Needle Adjustment Setup] ----- Loop:1 1. Normal 2. Precise (now) Select:  -----
	Press numbers to set repeat times for needle calibration. Then press ENTER. I.e. To set repeat times is 3.	[Needle Adjustment Setup] ----- Loop:3 1.Fast 2.Precise (now) Select:

<i>Instruction</i>	<i>Display Shows</i>
Select needle calibration mode. Then press ENTER. I.e. To set calibration mode to Fast, press 1 then press ENTER.	[Needle Adjustment Setup] ----- Loop:3 1.Fast (now) 2.Precise Select:1

# SECTION 6: Sample Programs

## 6.1 Dots, Lines and Arcs

At typical program, containing dots, lines, and arcs, would appear as follows:

<b>Addr.</b>	<b>Command</b>	<b>Notes</b>
0001	Line Speed ( 50 mm/s )	Sets the line speed to 50 mm/sec
0002	Line Dispense Setup <ul style="list-style-type: none"> <li>- Head Time: 0.30 sec</li> <li>- Tail Time: 0.25 sec</li> <li>- Node Time: 0.10 sec</li> <li>- Tail Length: 5 mm</li> </ul>	<p>Sets a wait time of 0.30 seconds at the start of all lines to give the material time to flow before moving along the line.</p> <p>Sets a wait time of 0.25 seconds at the end of all lines to give the material time to stop flowing before raising the tip.</p> <p>Sets a wait time of 0.10 sec at line passing point with the dispenser on.</p> <p>Sets a length of 5mm before the end of the line where the dispenser will be off.</p>
0003	Point Dispense Setup <ul style="list-style-type: none"> <li>- Dispense Time: 0.50 sec</li> <li>- Tail Time: 0.25 sec</li> </ul>	<p>Sets the dispensing time for all dots to 0.5 seconds.</p> <p>Sets the waiting time, after dispensing a dot, to 0.25 seconds.</p>
0004	Dispense End Setup <ul style="list-style-type: none"> <li>- H. Speed: 75 mm/sec</li> <li>- L. Speed: 15 mm/sec</li> <li>- L. Length: 10 mm</li> </ul>	<p>Programs the robot to rise, after dispensing dots and at the end of line dispensing.</p> <p>The tip will rise 10 mm (L. Length) at 15 mm/sec (L. Speed) then continues rising at 75 mm/sec (H. Speed) to the Z Clearance height.</p>
0005	Z Clearance <ul style="list-style-type: none"> <li>- 20 mm</li> <li>- Relative</li> </ul>	<p>Sets the Z Clearance value to 20 mm relative to the point location.</p> <p>The maximum height the tip will rise after dispensing is 20 mm above the Dot or Line End point</p>

Addr.	Command	Notes
0006	Line Start (10, 10, 35)	Registers a Line Start point at X: 10 mm, Y: 10 mm, Z: 35 mm
0007	Line Passing (10, 20, 35)	Registers a Line Passing point at X: 10 mm, Y: 20 mm, Z: 35 mm
0008	Arc (5, 25, 35)	Registers an Arc point at X: 5 mm, Y: 25 mm, Z: 35 mm
0009	Line Passing (10, 30, 35)	Registers a Line Passing point at X: 10 mm, Y: 30 mm, Z: 35 mm
0010	Line End (10, 40, 35)	Registers a Line End point at X: 10 mm, Y: 40 mm, Z: 35 mm
0011	Dispense Dot (20, 20, 35)	Dispenses a dot at X: 20 mm, Y: 20 mm, Z: 35 mm
0012	Dispense Dot (20, 25, 35)	Dispenses a dot at X: 20 mm, Y: 25 mm, Z: 35 mm
0013	Dispense Dot (20, 30, 35)	Dispenses a dot at X: 20 mm, Y: 30 mm, Z: 35 mm
0014	End Program	Ends the program. Returns the tip to the home position.



## 6.2 Brush Area

<b>Addr.</b>	<b>Command</b>	<b>Notes</b>
0001	Line Speed ( 25 mm/s )	Sets the line speed to 25 mm/sec
0002	Line Dispense Setup - Head Time: 0.30 sec - Tail Time: 0.25 sec - Node Time: 0.10 sec - Tail Length: 5 mm	Sets a wait time of 0.30 seconds at the start of all lines to give the material time to flow before moving along the line.  Sets a wait time of 0.25 seconds at the end of all lines to give the material time to stop flowing before raising the tip.  Sets a wait time of 0.10 sec at line passing point with the dispenser on.  Sets a length of 5mm before the end of the line where the dispenser will be off.
0003	Dispense End Setup - H. Speed: 75 mm/sec - L. Speed: 15 mm/sec - L. Length: 10 mm	Programs the robot to rise, after dispensing.  The tip will rise 10 mm (L. Length) at 15 mm/sec (L. Speed) then continues rising at 75 mm/sec (H. Speed) to the Z Clearance height.
0004	Z Clearance - 20 mm - Relative	Sets the Z Clearance value to 20 mm relative to the point location.  The maximum height the tip will rise after dispensing is 20 mm above the Line End point
0005	Brush Area - Rectangle - Brush Width: 5 mm	Sets a Rectangle area to be brushed with a brush width of 5 mm.
0006	Line Start (50, 10, 35)	Registers a Line Start point at X: 50 mm, Y: 10 mm, Z: 35 mm. This is the top left corner of the area to be brushed.
0007	Line End (90, 60, 35)	Registers a Line End point at X: 90 mm, Y: 60 mm, Z: 35 mm. This is the lower right corner of the area to be brushed.
0008	End Program	Ends the program. Returns the tip to the home position.

### 6.3 Step & Repeat

The program below will dispense four dots on each work piece.

There are three rows and four columns of parts loaded on the robot for a total of 12 parts.

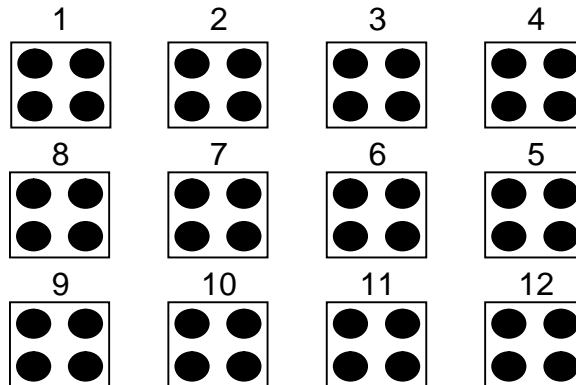

The parts are 25 mm apart in the X-axis.

The parts are 30 mm apart in the Y-axis.

<b>Addr.</b>	<b>Command</b>	<b>Notes</b>
0001	Point Dispense Setup - Dispense Time: 0.50 sec - Tail Time: 0.25 sec	Sets the dispensing time for all dots to 0.5 seconds.  Sets the waiting time, after dispensing a dot, to 0.25 seconds.
0002	Dispense End Setup - H. Speed: 75 mm/sec - L. Speed: 15 mm/sec - L. Length: 10 mm	Programs the robot to rise, after dispensing.  The tip will rise 10 mm (L. Length) at 15 mm/sec (L. Speed) then continues rising at 75 mm/sec (H. Speed) to the Z Clearance height.
0003	Z Clearance - 20 mm - Relative	Sets the Z Clearance value to 20 mm relative to the point location.  The maximum height the tip will raise after dispensing is 20 mm above the Dot.

<b>Addr.</b>	<b>Command</b>	<b>Notes</b>
0004	Dispense Dot (180, 20, 35)	Dispenses a dot at X: 180 mm, Y: 20 mm, Z: 35 mm  (First Part, first dot)
0005	Dispense Dot (180, 25, 35)	Dispenses a dot at X: 180 mm, Y: 25 mm, Z: 35 mm  (First Part, second dot)
0006	Dispense Dot (185, 20, 35)	Dispenses a dot at X: 185 mm, Y: 20 mm, Z: 35 mm  (First Part, third dot)
0007	Dispense Dot (185, 25, 35)	Dispenses a dot at X: 185 mm, Y: 25 mm, Z: 35 mm  (First Part, four dot)
0008	<p>Step &amp; Repeat Y</p> <ul style="list-style-type: none"> <li>- Columns: 4</li> <li>- Rows: 3</li> <li>- X Offset: 25 mm</li> <li>- Y Offset: 30 mm</li> <li>- Start Address: 4</li> <li>- 'S' Path</li> </ul>	<p>Registers the Step &amp; Repeat instruction.</p> <p>The robot will repeat addresses 0004 – 0007 to complete a matrix of 4x3 (12) parts.</p> <p>The distance between parts is 25 mm in the X-axis and 30 mm in the Y-axis.</p> <p>The robot will follow an 'S' path, through the parts.</p>
0009	End Program	Ends the program. Returns the tip to the home position.

## 6.4 Input / Output Signal Processing

The program below assumes a fixture holding 12 parts. The robot will move to the first part, then close output signal # 1 for 0.25 seconds.

The robot will then check the status of input signal #1 at the first part.

If the signal is closed, the robot will dispense a dot then move to the next part.

If the signal does not close within (2) seconds, the robot will skip this part and move to the next part. This process will be repeated for all (12) parts.

<b>Addr.</b>	<b>Command</b>	<b>Notes</b>
0001	Point Dispense Setup - Dispense Time: 0.50 sec - Tail Time: 0.25 sec	Sets the dispensing time for all dots to 0.5 seconds.  Sets the waiting time, after dispensing a dot, to 0.25 seconds.
0002	Dispense End Setup - H. Speed: 75 mm/sec - L. Speed: 15 mm/sec - L. Length: 10 mm	Programs the robot to rise, after dispensing.  The tip will rise 10 mm (L. Length) at 15 mm/sec (L. Speed) then continues rising at 75 mm/sec (H. Speed) to the Z Clearance height.
0003	Z Clearance - 20 mm - Relative	Sets the Z Clearance value to 20 mm relative to the point location.  The maximum height the tip will rise after dispensing is 20 mm above the Dot.
0004	Dummy Point (180, 20, 25)	Registers a 'Dummy' point at: X: 180 mm, Y: 20 mm, Z: 25 mm  The tip will move to this XYZ location, but will do nothing. This point is just above the first part in the fixture.
0005	Set INPUT / OUTPUT - Output - Port #: 1 - Status: 1	Closes output signal # 1.  Output is turned 'on.'

<b>Addr.</b>	<b>Command</b>	<b>Notes</b>
0006	WAIT POINT - Time: 0.25 sec	Wait for 0.25 seconds
0007	Set INPUT / OUTPUT - Output - Port #: 1 - Status: 0	Open output signal # 1.  Output is turned 'off.'
0008	Set INPUT / OUTPUT  - Input - Port #: 1 - Status: 0 - GOTO Addr: 12	Check the status of input signal # 1.  If the input signal is closed (pin #1 is connected to ground / pin 13), the robot will go to address #0012.  If input signal #1 is open (pin #1 is not connected to ground), the program will continue at address #0009
0009	Wait Point - Time: 0.20 seconds	Wait for 0.20 seconds
0010	LOOP ADDRESS - Count: 10 - Address: 8	Repeat instructions 0008 – 0009 (10) times. (10) times a wait time of 0.20 seconds = 2.00 seconds.
0011	GOTO Addr. 0013	If, after 2.0 seconds, the input signal never closed, GOTO address #0013 (Skip the dot dispensing).
0012	Dispense Dot (180,20,35)	Dispenses a dot at X: 180 mm, Y: 20 mm, Z: 35 mm (Dot on the first part in the fixture)
0013	Step & Repeat Y  - Columns: 4 - Rows: 3 - X Offset: 25 mm - Y Offset: 30 mm - Start Address: 4 - 'S' Path	Registers the Step & Repeat instruction.  The robot will repeat addresses 0004 – 0011 to complete a matrix of 4x3 (12) parts.  The distance between parts is 25 mm in the X-axis and 30 mm in the Y-axis.  The robot will follow an 'S' Path, through the parts.
0014	End Program	Ends the program. Returns the tip to the home position.

## 6.5 Needle Calibration

The program as below showing how to use needle calibration features.

Robot will perform needle calibration before dispensing. And will repeat if the needle calibration counter numbers has been reached. .

<b>Addr.</b>	<b>Command</b>	<b>Notes</b>
0001	Needle Adjustment	Robot performing needle calibration before dispensing start.
0002	Needle Adjustment counter (5)	Perform needle calibration by every 5 cycles.
0003	Line Speed ( 50 mm/s )	Sets the line speed to 50 mm/sec
0004	Line Start (10, 10, 35)	Registers a Line Start point at X: 10 mm, Y: 10 mm, Z: 35 mm
0005	Line Passing (10, 20, 35)	Registers a Line Passing point at X: 10 mm, Y: 20 mm, Z: 35 mm
0006	Line End (10, 40, 35)	Registers a Line End point at X: 10 mm, Y: 40 mm, Z: 35 mm
0007	End Program	Ends the program. Returns the tip to the home position.

# SECTION 7: Software Upgrade

---

## 7.1 Check System Version

---

To check Robot system software version:

Press F3->2<sup>nd</sup> Page->System information

Then software version will be show up at Teach Pendant's screen.

**NOTE:** If you find the version is **A 1.XX**, that's means your system is not allowed to upgrade at this point.

---

## 7.2 Upgrade Software

---

**NOTE:** To upgrade the software, it will use the USB memory stick 8902898 which comes with Henkel Robot system, or you need a USB memory stick which meets below requirements.

- A. Capacity lower than 2G bytes.
- B. Format as FAT.

### Upgrade Procedure

1. Create an "UPDATA" folder on the root of Memory stick.
2. Copy upgrade file (autoexec.bat; dxt.com; g.exe) to UPDATA folder.
3. Make sure Robot was POWER OFF.
4. Plug USB memory stick into USB port on Robot panel.
5. Power ON Robot.
6. Robot will detect upgrade file on the USB, and upgrade firmware automatically. The upgrade process should take about 1 minute. Robot will initialize once upgrade is completed.
7. Check software version information to make sure it have been accomplished.
8. Remove USB memory stick.



# SECTION 8: Error Messages

---

## **8.1 Point Closed Error**

---

This message occurs when two adjacent line or arc points are registered at exactly the same XYZ location.

Resolution: Do not register two line points one after the other at exactly the same XYZ location.

---

### **8.1.1 Need Line Start Point**

---

An attempt was made to register a Line Passing point, an Arc point or a Line End point without first registering a Line Start point.

Resolution: Register a Line Start point before registering a Line Passing point, Arc point or a Line End point.

---

### **8.1.2 Need Step & Repeat**

---

The Expand Step & Repeat command was given but there is no Step & Repeat instruction currently in the display.

Resolution: Select the Step & Repeat function you want to expand before selecting Expand Step & Repeat.

---

### **8.1.3 Unlock Program**

---

An attempt was made to edit a program in Teach mode, which is locked. The program cannot be edited until it is unlocked.

Resolution: Unlock the program in **F2 Menu → Utility Menu → Lock Program**.

---

### **8.1.4 Address Over Memory**

---

An attempt was made to copy data but the copy would exceed the maximum memory address.

Resolution: Reduce the data to be copied.

---

### **8.1.5 Move Over Memory**

---

An attempt was made to move data but the move would exceed the maximum memory address.

Resolution: Reduce the data to be moved.

---

### **8.1.6 System Error**

---

This message indicates a problem with the CF Memory card.

Resolution: Please contact your dealer.

---

### **8.1.7 Over Speed Error**

---

This message indicates the setting speed of the address showed on the screen are over the maximum allowed speed for the robot. This error may caused by high speed running for very short path, shaft corner or small arc/circle.

Note: When an error occurs, it will be displayed on the Teach Pendant. If the Teach Pendant is not connected to the robot, you will first have to turn off the robot, then connect the Teach Pendant to the robot for it to properly function.

# SECTION 9: Equipment Warranty

---

## **9.1 Equipment Warranty**

---

### **For Loctite® D-Series Benchtop Robot**

Henkel expressly warrants that all products referred to in this Instruction Loctite® D-Series Benchtop Robots (hereafter called “Products”) shall be free from defects in materials and workmanship. Liability for Henkel shall be limited, at its option, to replacing those Products which are shown to be defective either in materials or workmanship or to credit to the purchaser the amount of the purchase price thereof (plus freight and insurance charges paid therefore by the user). The purchaser’s sole and exclusive remedy for breach of warranty shall be such replacement or credit.

A claim of defect in materials or workmanship in any Products shall be allowed only when it is submitted to Henkel in writing within one month after discovery of the defect or after the time the defect should reasonably have been discovered and in any event, within twelve months after the delivery of the Products to the purchaser. No such claim shall be allowed in respect of Products which have been neglected or improperly stored, transported, handled, installed, connected, operated, used or maintained or in the event of unauthorized modification of the Products including, where products, parts or attachments for use in connection with the Products are available from Henkel, the use of products, parts or attachments which are not manufactured by Henkel.

No Products shall be returned to Henkel for any reason without prior written approval from Henkel. Products shall be returned freight prepaid, in accordance with instructions from Henkel.

**NO WARRANTY IS EXTENDED TO ANY EQUIPMENT WHICH HAS BEEN ALTERED, MISUSED, NEGLECTED, OR DAMAGED BY ACCIDENT.**

**EXCEPT FOR THE EXPRESS WARRANTY CONTAINED IN THIS SECTION, HENKEL MAKES NO WARRANTY OF ANY KIND WHATSOEVER, EXPRESS OR IMPLIED, WITH RESPECT TO THE PRODUCTS.**

**ALL WARRANTIES OF MERCHANTABILITY, FITNESS FOR A PARTICULAR PURPOSE, AND OTHER WARRANTIES OF WHATEVER KIND (INCLUDING AGAINST PATENT OR TRADEMARK INFRINGEMENT) ARE HEREBY DISCLAIMED BY HENKEL AND WAIVED BY THE PURCHASER.**

**THIS SECTION SETS FORTH EXCLUSIVELY ALL OF LIABILITY FOR HENKEL TO THE PURCHASER IN CONTRACT, IN TORT OR OTHERWISE IN THE EVENT OF DEFECTIVE PRODUCTS.**

**WITHOUT LIMITATION OF THE FOREGOING, TO THE FULLEST EXTENT POSSIBLE UNDER APPLICABLE LAWS, HENKEL EXPRESSLY DISCLAIMS ANY LIABILITY WHATSOEVER FOR ANY DAMAGES INCURRED DIRECTLY OR INDIRECTLY IN CONNECTION WITH THE SALE OR USE OF, OR OTHERWISE IN CONNECTION WITH, THE PRODUCTS, INCLUDING, WITHOUT LIMITATION, LOSS OF PROFITS AND SPECIAL, INDIRECT OR CONSEQUENTIAL DAMAGES, WHETHER CAUSED BY NEGLIGENCE FROM HENKEL OR OTHERWISE.**

# Operating Manual

## Section 9: Warranty

---

Henkel Corporation  
One Henkel Way  
Rocky Hill, CT 06067-3910  
USA

Henkel Canada Corporation  
2225 Meadowpine Boulevard  
Mississauga, Ontario L5N 7P2  
CANADA

Henkel Corporation  
Automotive/ Metals H.Q.  
32100 Stephenson Hwy,  
Madison Heights 48071  
USA

Henkel Capital, S.A. de C.V.  
Calzada de la Viga s/n Fracc.  
Los Laureles  
Loc. Tulpetlac, C.P. 55090  
Ecatepec de Morelos, MEXICO

Henkel Singapore Pte Ltd  
401, Commonwealth Drive  
#03-01/02 Haw Par Technocentre  
SINGAPORE 149598

Henkel (China) Company Ltd.  
No. 928 Zhang Heng Road,  
Zhangjiang, Hi-Tech Park, Pudong,  
Shanghai, China 201203

Henkel Loctite Korea  
8F, Mapo Tower, 418,  
Mapo-dong, Mapo-gu,  
Seoul, 121-734, KOREA

Henkel Japan Ltd.  
27-7 Shin Isogo-cho, Isogo-ku  
Yokohama, 235-0017  
JAPAN

[www.equipment.loctite.com](http://www.equipment.loctite.com)

**Loctite is a trademark of Henkel Corporation, U.S.A. © Copyright 2006. Henkel Corporation**

**Teflon is a registered trademark of E.I. DuPont de Nemours Co., Inc.**

**All rights reserved. Data in this operation manual is subject to change without notice.**

**Manual P/N: 8902886, Rev A, Date: 12/2011**

