

LOCTITE®

EQUIPMENT Operation Manual



Digital Syringe Dispenser

Part Number 97006

Henkel Technologies

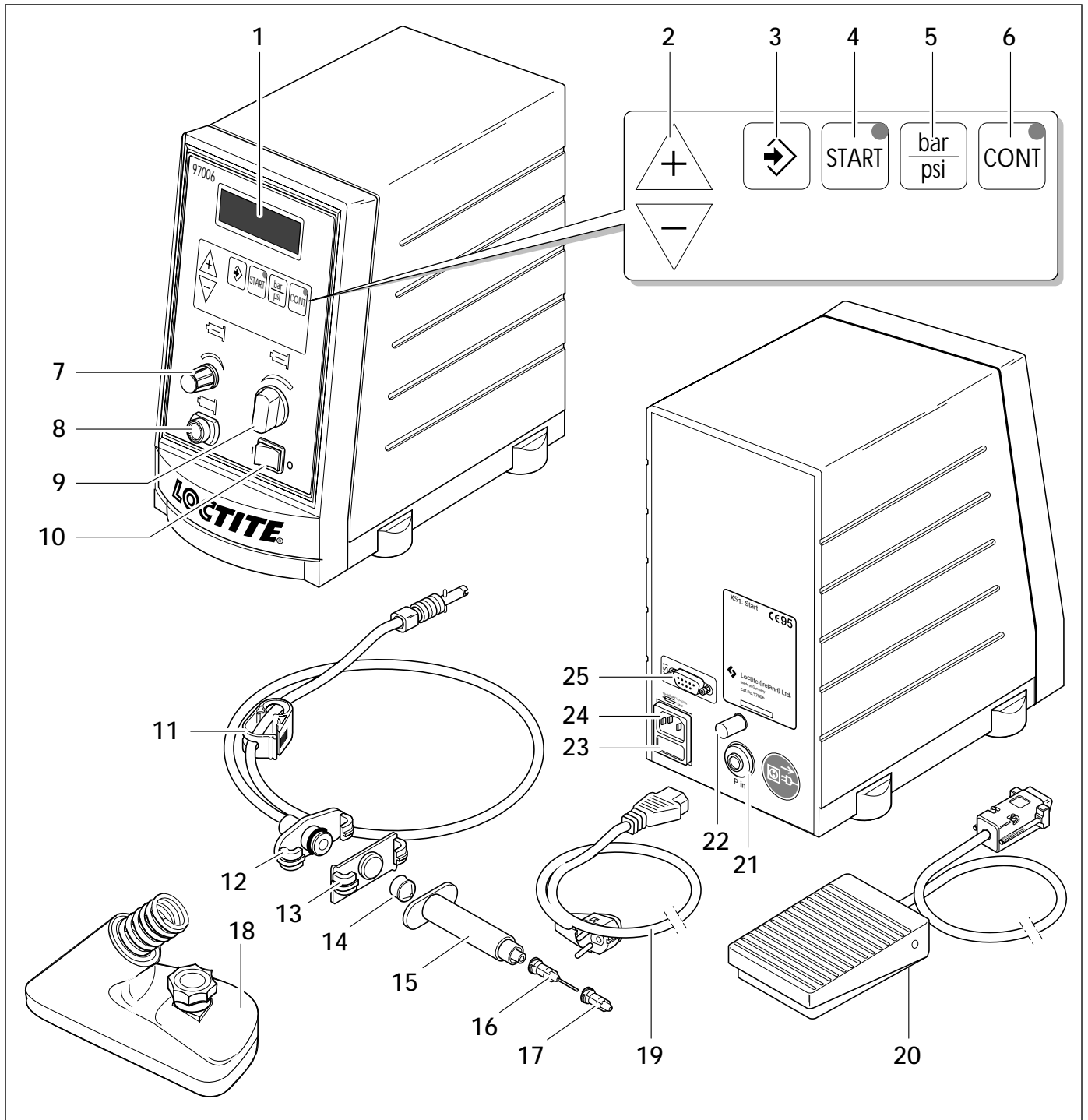

Contents

1 Please observe the following

- 1.1 Emphasized Sections
- 1.2 Items Supplied
- 1.3 For Your Safety
- 1.4 Usage

2 Description

- 2.1 Displays, Operating Elements, and Connections
- 2.2 Theory of Operation
- 2.3 Functional Sequence
 - 2.3.1 Time Controlled Mode
 - 2.3.2 **Continuous Mode**

3 Technical Data

- 3.1 Energy Requirements
 - 3.1.1 Electrics
 - 3.1.2 Pneumatics
- 3.2 Connections and Dimensions
- 3.3 Other Data

4 Installation

- 4.1 Environmental Conditions
- 4.2 Space Requirements
- 4.3 Placement
- 4.4 Basic Settings of the Unit
- 4.5 Connecting the Unit

Contents

5 Dispensing

- 5.1 Filling the Syringe
- 5.2 First Operation
 - 5.2.1 Purging Air from the Syringe
 - 5.2.2 Adjusting the Dispensed Quantity
 - 5.2.2.1 Time Controlled Mode
 - 5.2.2.2 **Continuous Mode**
- 5.3 Changing the Syringe
- 5.4 Shutdown
- 5.5 Returning to Operation

6 Care and Maintenance

- 6.1 Care
- 6.2 Maintenance

7 Troubleshooting

8 Documentation

- 8.1 Pin Connections for Foot Switch Cable
- 8.2 Accessories and Spare Parts

9 Declarations of Conformity

- 9.1 Declarations of Conformity
- 9.2 Warranty
- 9.3 Service Representative

1

Please observe the following

1.1 Emphasized Sections

Warning!



Refers to safety regulations and requires safety measures that protect the operator or other persons from injury or danger to life.

Caution!



Emphasizes what must be done or avoided so that the unit or other property is not damaged.

Notice



Gives recommendations for better handling of the unit during operation or adjustment as well as for service activities.

The numbers printed in bold in the text refer to the corresponding position numbers in the illustration on the front fold-out page (see Section 2.1).

- The point emphasizes an instruction step. Instruction steps in the illustrations are indicated with arrows.

When several instruction steps are indicated in an illustration, the shading of the arrow has the following meaning:

- Black arrow = 1st step
- Grey arrow = 2nd step
- White arrow = 3rd step

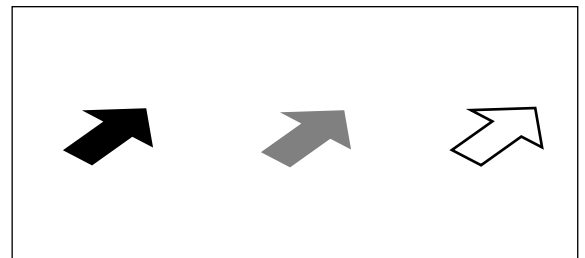

1.2 Items Supplied

- 1 Digital Syringe Dispenser 97006
- 1 Power Cord
- 1 Foot switch
- 1 Needle Sample Kit
- 1 Instruction Manual 97006



As a result of technical development, the illustrations and descriptions in this instruction manual can deviate in detail from the actual unit delivered.

1

Please observe the following

1.3 For Your Safety



For safe and successful operation of the unit, read these instructions completely. If the instructions are not observed, the manufacturer can assume no responsibility.



Damage to the power cord or the housing can result in contact with voltage carrying parts that is dangerous to life.

- Check the power cord and the unit before each use.
If the power cord or the unit is damaged, do not operate!
Replace a damaged power cord with a new one.
- The unit may be opened and repaired only by an authorized Henkel service representative.



If Loctite® brand products are not properly handled, damage to health can result!

- Observe general safety regulations for the handling of chemicals!
- Observe manufacturer's instructions! Request a safety data sheet for the product used!
- Always wear goggles, when operating with pressurized air!

1.4 Usage

The Loctite® Digital Syringe Dispenser (97006) is suitable for the exact application of Loctite® brand products at manual workstations such as in workshops, laboratories and industrial installations.

It is a self-contained dispenser system.

The Loctite® Digital Syringe Dispenser (97006) is designed for a product application position and for small quantities.

With the Loctite® Digital Syringe Dispenser (97006), Loctite® brand anaerobic, UV curing and gel cyanoacrylate adhesives as well as Loctite® brand chipbonder® adhesives and soldering flux can be dispensed.

2

Description - Typical System Set-Up

2.1 Displays, Operating Elements, and Connections

-  ● Fold out the illustration inside the front cover!

1 Digital Display

Display of the dispensing time[s] for a dispensing sequence.





- During dispensing in time controlled mode, the dispensing time remaining is indicated.
- During dispensing in **continuous** mode, the elapsed dispensing time is indicated.

Display of the dispensing pressure [bar or psi] set on the pressure regulator **9**.

Display of error messages (see Chapter 7).

2 Button or

Buttons for changing the dispensing time for a dispensing sequence.

When button  or  is pressed, the display of the dispensing time[s] in the digital display begins to blink. The dispensing time indicated is increased with button  and decreased with button . The dispensing time is adjustable from 0.01 to 99.9 s.

3 Button

Button for the storage of the new values set for the dispensing time[s] and the dispensing pressure [bar or psi].

When the indication of the dispensing time[s] in the digital display blinks, the indicated dispensing time is stored by pressing button  and the display stops blinking.

For an error message "**Press. 0.83 NOK**" with beeping, the error message is acknowledged by pressing button . The value **0.83** [bar/psi] is only an example for the indication of a dispensing pressure (see Chapter 7).

4 Button

Button for starting a dispensing sequence. The LED lights for the duration of the dispensing sequence.

The dispensing time in time controlled mode corresponds to the value on the digital display and is independent of the length of time that button  is pressed (see Section 2.3.1).

In **continuous** mode, the product is dispensed as long as button  is pressed (see Section 2.3.2).

2

Description - Typical System Set-Up

5 Button

Button for switching the measuring units for the dispensing pressure in the digital display.





After each pressing of button , the indication of the selected dispensing pressure in the digital display changes to the other measuring unit [bar or psi] with the corresponding value.

6 Button

Button for switching from time controlled mode to **continuous** mode.

The lighting of the LED in button  indicates continuous mode (see Section 5.2.2.2).

By pressing button , the indication of the dispensing time in the digital display is set to 0.00 s and blinks. During dispensing, the elapsed dispensing time is indicated in the digital display beginning each time with 0.00 s. The last dispensing time remains displayed until the next start.

- Switch back to time controlled mode **without storage** of the dispensing time by repeated pressing of button . The LED in button  extinguishes. In the digital display, the dispensing time previously stored for the time controlled mode reappears.
- Switch back to time controlled mode **with storage** of the dispensing time by pressing button . The LED in button  extinguishes. The indicated dispensing time is stored and the display stops blinking.

7 Vacuum Control

Control for pulling a vacuum in the syringe.

With this vacuum, the product is sucked back during dispensing pauses to prevent dripping.

- Turning in the counter clockwise direction: The vacuum action is increased until the dripping stops.
- Turning in the clockwise direction: The vacuum action is reduced.

8 Pneumatic Connection for Syringes (Outlet)

9 Precision Pressure Regulator

Precision regulator for adjusting the dispensing pressure.

By turning the regulator knob, the dispensing pressure is adjusted in the range from 0.00 to 7.00 bar (0.00 to 100 psi).

If the error message "**Press. 0.83 NOK**" appears with beeping, the dispensing pressure was changed more than $\pm 10\%$. The value **0.83** [bar/psi] is only an example for the displayed dispensing pressure (see Chapter 7).

By pressing button , the indicated dispensing pressure is stored as the new comparison value for automatic pressure monitoring. The error message and beeping are eliminated.

10 Power Switch I/O (ON/OFF)

2

Description - Typical System Set-Up

11 Hose Clamp

12 Syringe Air Line Adapter Assembly

13 End Cap Adapter

14 Plug

Makes possible the clean emptying of the Syringe **15** and prevents the permeating of the product with air as well as the product running back out of the Syringe **15** into the control unit.

15 Syringe



Store filled syringes only with Luer-Lock tip caps **17** or end caps **13**.

16 Dispensing needle

17 Luer-Lock Tip Cap

18 Pencil Holder

19 Power Cord

20 Foot Switch

Functions in the same manner as button .

21 Pneumatic Connection "P" in

22 Exhaust Air Silencer

When necessary, can be replaced with a micro-filter or a hose connection to collect the exhaust air.

23 Power Fuse



Removal of safety devices or making them inoperable can result in damage to the unit and therefore prohibited!

24 Power Supply Socket

25 Socket XS1: Start

The Foot Switch **20** is connected here.

2

Description - Typical System Set-Up

2.2 Theory of Operation

The Loctite® Digital Syringe Dispenser (97006) is connected to an external pneumatic supply. The Control Unit of 97006 regulates the adjusted dispensing pressure and controls the dispensing during the selected dispensing time. Pressure variations of more than 10 % result in an error message on the digital display (see Chapter 7).

By means of air pressure on the plug **14** in the syringe **15**, the product is transported to the dispensing needle **16**.

The built-in vacuum regulator prevents dripping of the product during pauses in dispensing.

2.3 Functional Sequence

2.3.1 Time Controlled Mode

Also see Section 5.2.2.1!

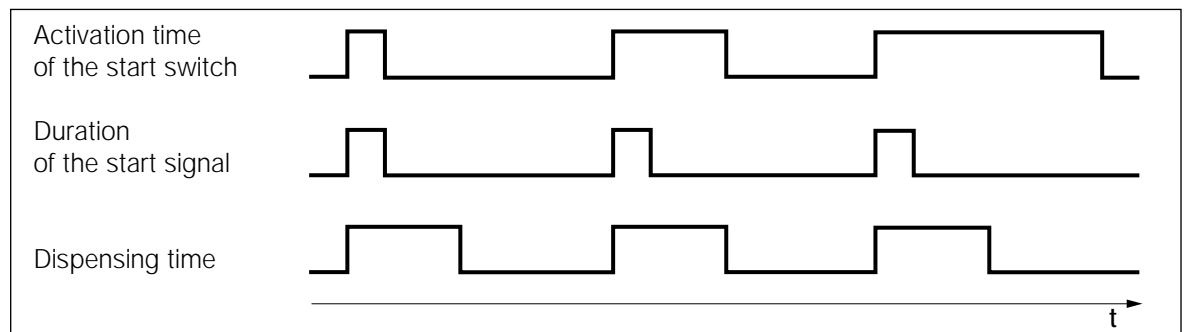

2.3.2 Continuous Mode

Also see Section 5.2.2.2!

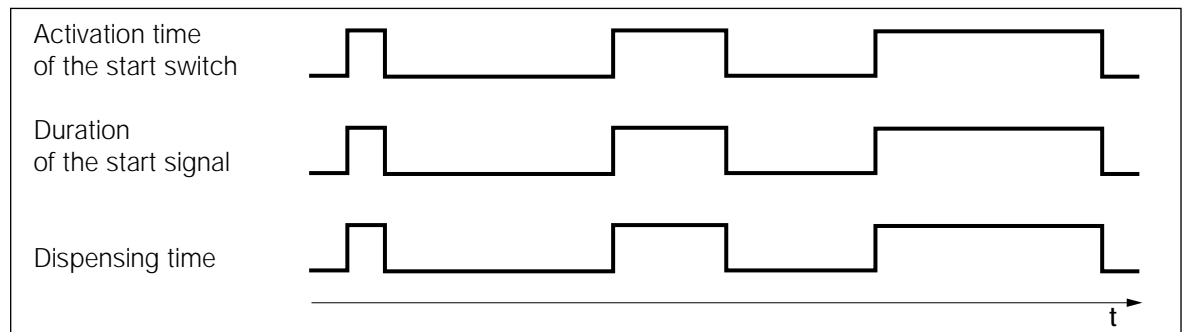

3 Technical Data

3.1 Energy Requirements

3.1.1 Electrics

Power supply	90 – 260 VAC; 47 – 63 Hz
Power consumption	Approx. 40 W
Power protection	Glass tube, fine wire fuse, 2 AM
Internal control voltages	5 VDC; 12 VDC; 24 VDC

3.1.2 Pneumatics

Pneumatic supply	min. 2 bar (29 psi); max. 12 bar (174 psi)
Quality If the required quality is not achieved, install a Loctite® brand filter regulator.	Filtered 10 µm, oil-free, non-condensing Accessory Order No. 985397
Regulation range of the pressure regulator	0.00 – 7.00 bar (0.00 – 100 psi)
Pressure indication	0.00 – 7.00 bar (0.00 – 100 psi)

3.2 Connections and Dimensions

Power connection	cold appliance coupl. IEC 320 acc. to VDE 0625
Pneumatic hose size	Internal dia. - 4 mm; external dia. - 6 mm ^{+0,05} _{-0,10}
Dimensions	W x H x D: 145 x 230 x 260 mm

3.3 Other Data

Protection grade	IP 33 acc. to VDE 0470, Part 1 / EN 60529-1991
Operating temperature	+10 °C to +40 °C (+50 °F to +104 °F)
Storage temperature	-10 °C to +60 °C (+14 °F to +140 °F)
Weight	3.0 kg
Continuous sound pressure level	< 65 dB(A)

4 Installation

4.1 Environmental Conditions

- ! - No condensing humidity
- - No splashing water

4.2 Space Requirements

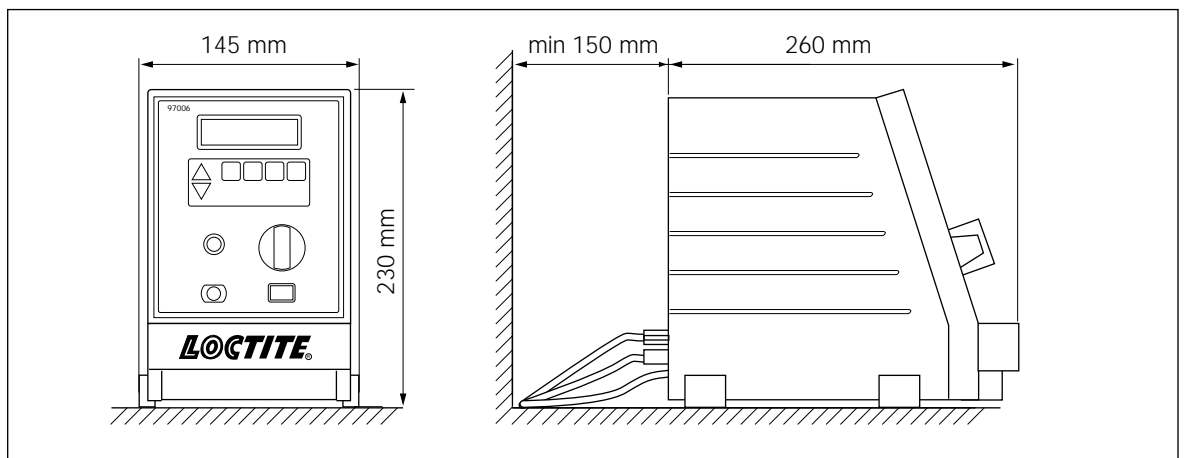

4.3 Placement

- ! When the plug 14 is missing and the syringe 15 is handled in an improper manner, the product can enter and contaminate the control unit.

- Place the control unit in a raised position!
- Do not hold the syringe 15 in an elevated position or with the tip pointing upward!
- In work pauses, press the hose clamp 11 closed!
- Hold the syringe correctly for uniform application of the product!

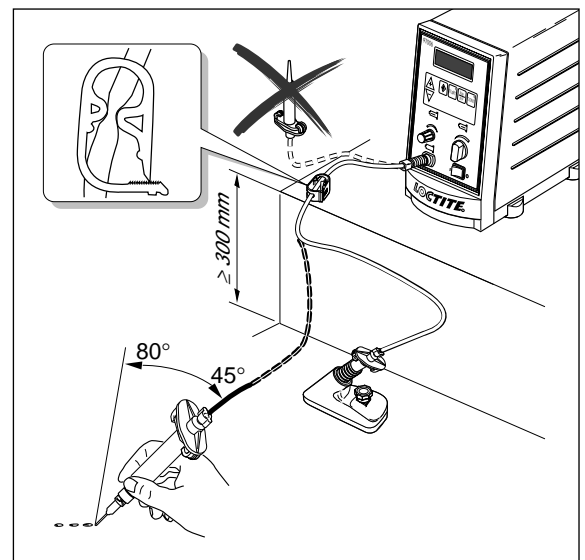

4

Installation

4.4 Basic Settings of the Unit

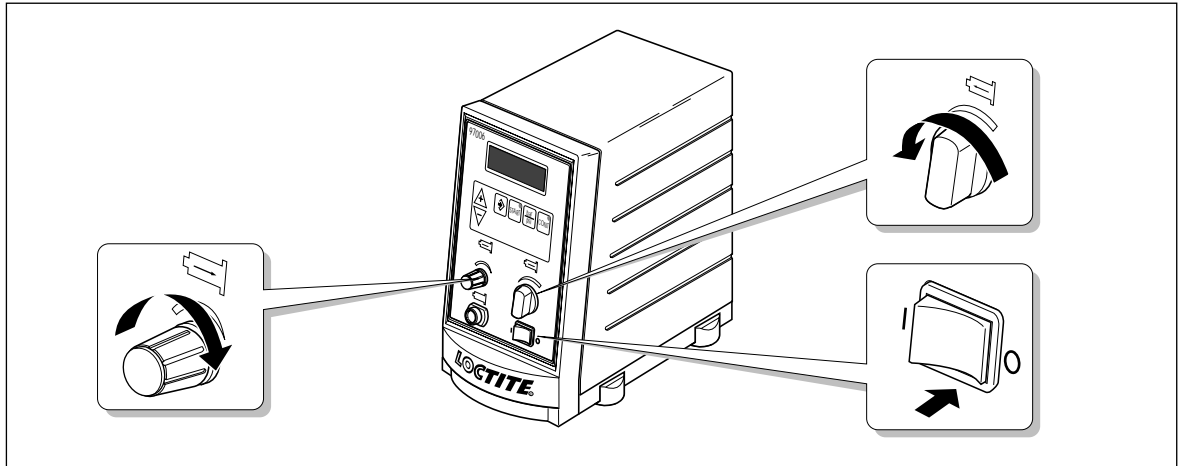

4.5 Connecting the Unit

- Use only the cable and hose sets supplied.

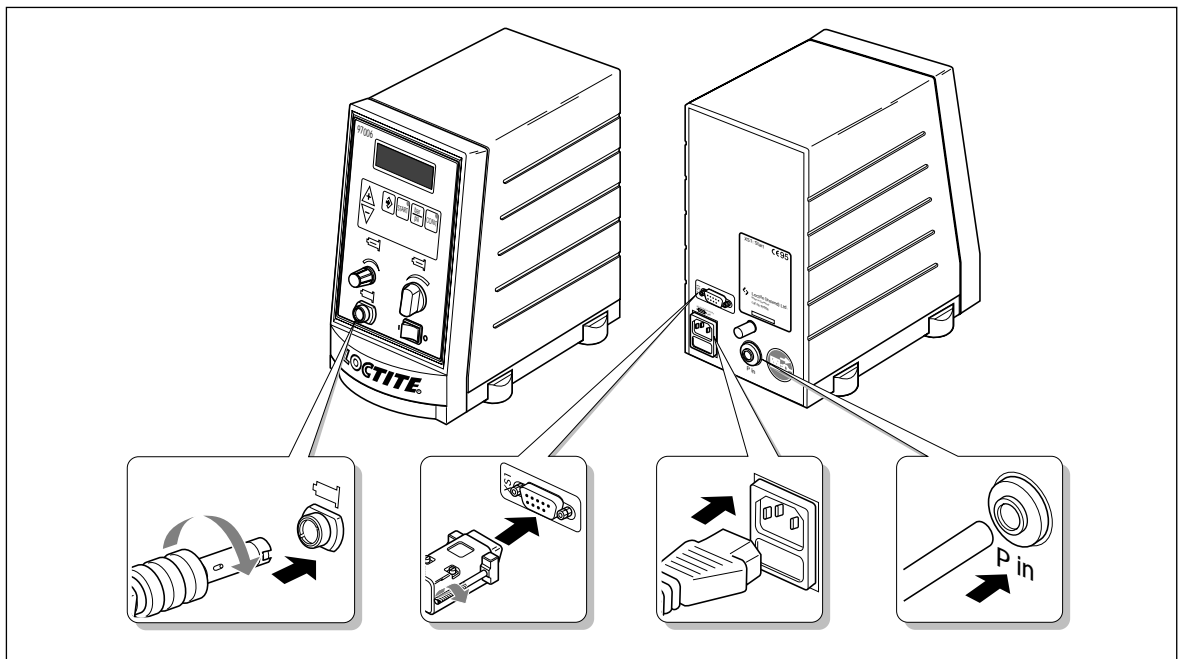

5

Dispensing

5.1 Filling the Syringe



If Loctite® brand products are not properly handled, damage to health can result!

- Observe general safety regulations for the handling of chemicals!
- Observe manufacturer's instructions! Request a safety data sheet for the product used!

- Close the tip of the syringe **15** with the Luer-Lock tip cap **17**.
- Hold the syringe **15** at an angle to prevent air bubbles during filling.
- Fill the product into the syringe **15**.

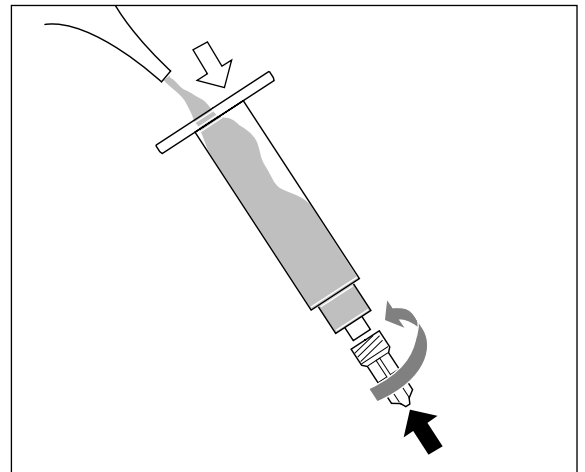

- Insert the plug **14** into the syringe **15**.



Depending on the dispensing task, fill several syringes **15** at the same time.

- ! Store filled syringes **15** only with Luer-Lock tip caps **17** and end caps **13**.

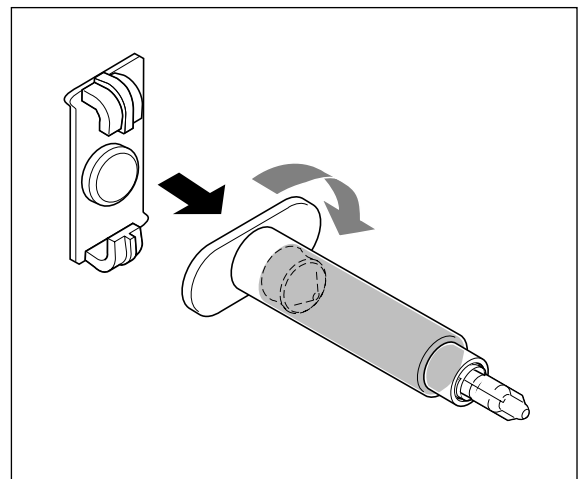

5

Dispensing

5.2 First Operation

5.2.1 Purging Air from the Syringe

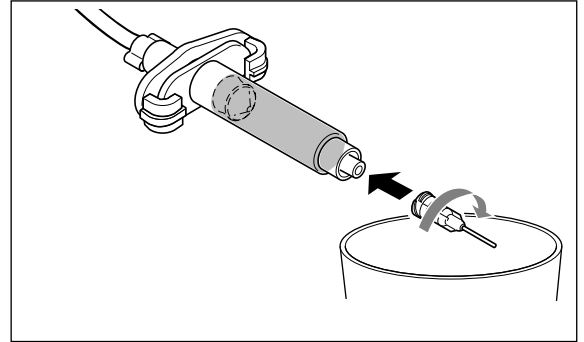
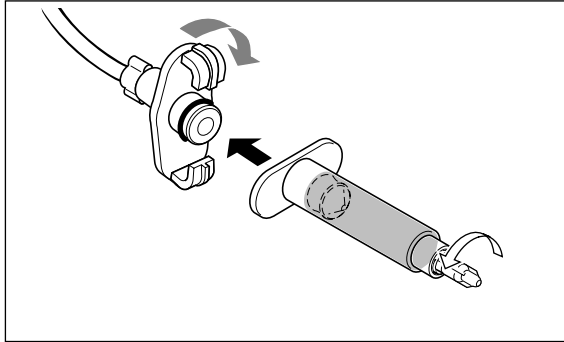

To avoid air bubbles during dispensing, the tip of the syringe must be purged of air.



- Hold the syringe **15** over a container since product will flow out!
- Switch the power switch **10** to the position I (ON).
- With the pressure regulator **9**, set the dispensing pressure to 0.50 bar (approx. 7.00 psi). The dispensing pressure set can be read from the digital display.

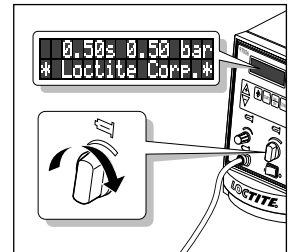
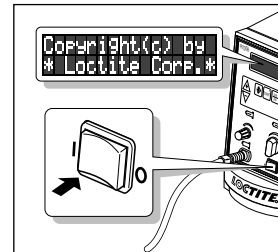

- Press button **CONT** to switch to **continuous** mode (see Section 5.2.2.2).
- Press and hold button **START** (or the Foot Switch **20**) until the product flows free of bubbles from the dispensing needle **16**.
- Press button **CONT** to switch off **continuous** mode.

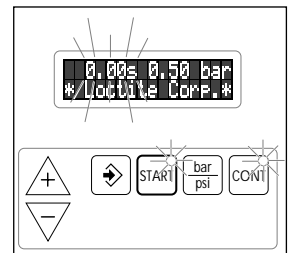
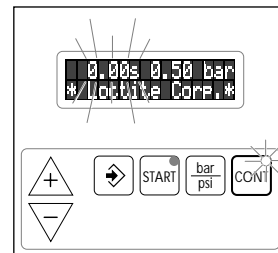

If the product drips out of the dispensing needle **16**:



- Turn the vacuum regulator **7** counter clockwise until the dripping stops.
- Do not continue turning after the dripping has stopped. When air is sucked in, the syringe must again be purged of air and curing of the product can occur!

5.2.2 Adjusting the Dispensed Quantity

5.2.2.1 Time Controlled Mode

This mode of operation is used for spot shaped wetting or drop dispensing.

- With buttons Δ or ∇ , set the dispensing time to 0.50 s (factory setting). The indication of the dispensing time in the digital display begins blinking.
- With the pressure regulator **9**, set the dispensing pressure to 0.50 bar (approx. 7 psi). An error message "**Press. 0.83 NOK**" with beeping is possible. The value **0.83** [bar/psi] is only an example for the indicated dispensing pressure (see Chapter 7).

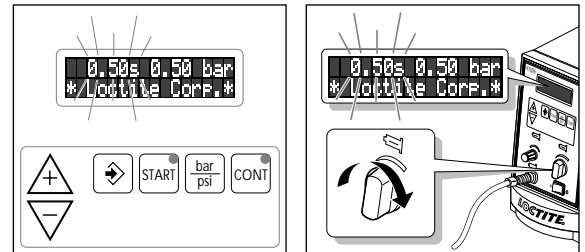

- Press button \rightarrow to store the dispensing pressure setting as the comparison value for automatic pressure monitoring. The error message with beeping is eliminated.
- Press button **START** (or the Foot Switch **20**) to check the dispensed quantity.

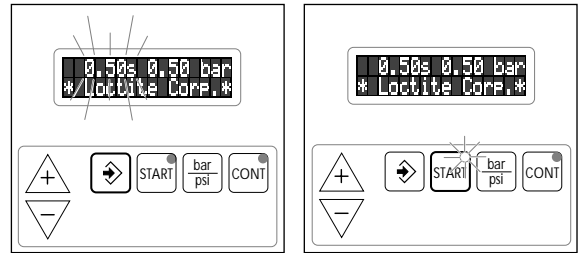

If the dispensed quantity is too small:

- Increase the dispensing pressure and store. Check the dispensed quantity again. Repeat this sequence until the desired dispense quantity is roughly achieved.

When the desired dispense quantity is roughly achieved:

- Set the exact dispensed quantity by changing the dispensing time with button Δ or ∇ .
- Press button **START** (or the Foot Switch **20**) to check the dispensed quantity.

Storing of the dispense quantity setting for subsequent dispensings:

- Press button \rightarrow . The indication of the dispensing time in the digital display stops blinking.

If the desired dispense quantity is not achieved:



- With a larger (or smaller) dispensing needle **16**, repeat the steps of Section 5.2.2.1.

5.2.2.2 Continuous Mode

This mode of operation is used for wettings of varying lengths or for the application of beads.

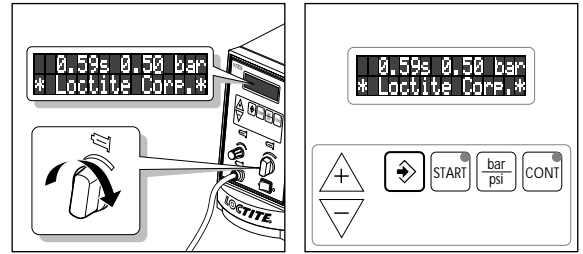
- With the pressure regulator **9**, set the dispensing pressure to 0.50 bar (approx. 7 psi). An error message "**Press. 0.83 NOK**" with beeping is possible. The value **0.83** [bar/psi] is only an example for the indicated dispensing pressure (see Chapter 7).
- Press button  to store the dispensing pressure setting as the comparison value for automatic pressure monitoring. The error message with beeping is eliminated.





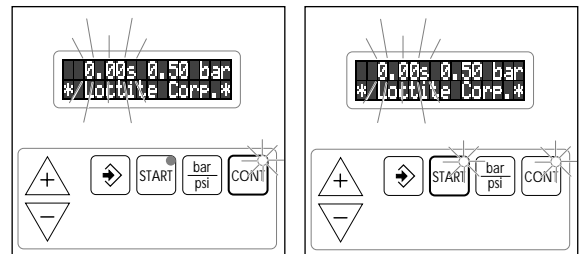

- Press button . The lighting of the LED in button  indicates **continuous mode**. The indication of the dispensing time in the digital display is set to 0.00 s and blinks.
- Press button  (or the Foot Switch **20**) until the dispensed quantity is roughly achieved.



When the dispense quantity is achieved too slowly:

- Increase the dispensing pressure and store. Check the dispense quantity again. Repeat this sequence until the desired dispense quantity is roughly achieved.



- Switch back to time controlled mode **without storage** of the dispensing time by repeated pressing of button . The LED in button  extinguishes. In the digital display, the dispensing time previously stored for the time controlled mode reappears.
- Switch back to time controlled mode **with storage** of the dispensing time by pressing button . The LED in button  extinguishes. The indicated dispensing time is stored and the display stops blinking.

If the desired dispense quantity is not achieved:

- With a larger (or smaller) dispensing needle **16**, repeat the steps of Section 5.2.2.2.

5

Dispensing

5.3 Changing the Syringe

The unit need not be switched off to change the syringe.

- ! ● Press the hose clamp **11** closed so that pressure cannot be applied to the syringe adapter **12** as a result of an unintentional start.

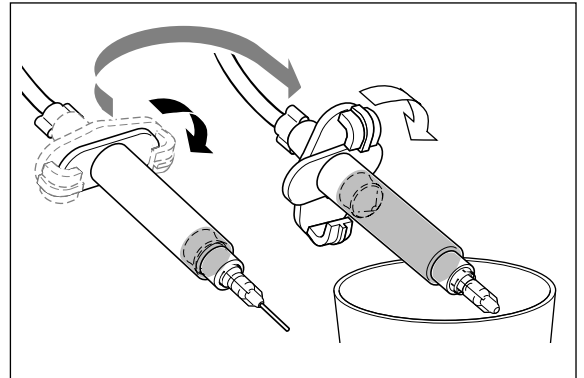
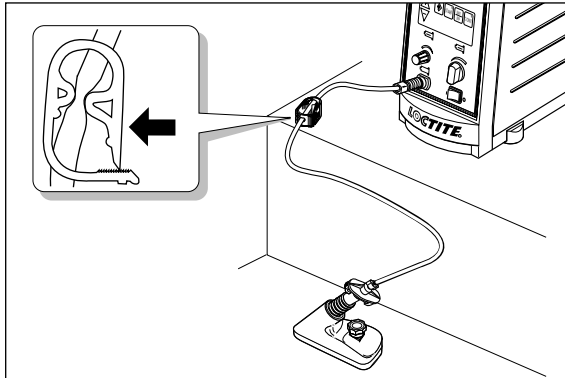

- Replace the Luer-Lock tip cap **17** on the filled syringe **15** with a dispensing needle **16**.
- Replace the syringe and release the hose clamp **11**.



To avoid air bubbles during dispensing, the tip of the syringe must be purged of air.

- ! ● Hold the syringe **15** over a container since product will flow out!

- Press button **CONT** to switch to **continuous** mode (see Section 5.2.2.2).
- Press and hold button **START** (or the Foot Switch **20**) until the product flows free of bubbles from the dispensing needle **16**.
- Press button **CONT** to switch off **continuous** mode.

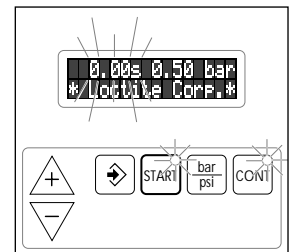
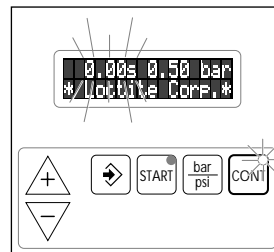

- Continue dispensing with the stored values or readjust the dispense quantity according to Section 5.2.2.

- ! ● For a change in the type of product, readjust the dispense quantity according to Section 5.2.2.

5

Dispensing

5.4 Shutdown

- Switch the power switch **10** to the position **O** (OFF).

Shutdown for Longer Periods of Non-use

! For pauses in the work of longer than 14 days, place the system out of operation to prevent curing of the product.

- Switch the power switch **10** to the position **O** (OFF).
- Disconnect the pneumatic supply.
- Remove the syringe **15**.

! Store filled syringes only with Luer-Lock tip caps **17** and end caps **13**. Dispose of the used syringes **15** and dispensing needles **16** in an environmentally correct manner!

5.5 Returning to Operation

- Switch the power switch **10** to the position **I** (ON).

The previously stored values are visible in the digital display.

- Press button  (or the Foot Switch **20**) to check the dispense quantity.

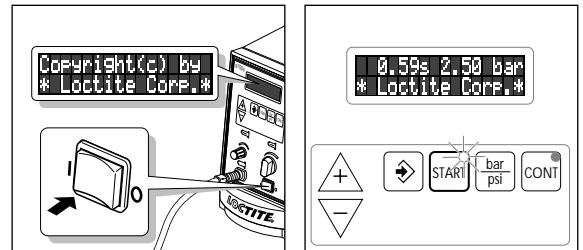

- Continue dispensing with the stored values or readjust the dispense quantity according to Section 5.2.2.

Returning to Operation after Longer Periods of Non-use

- Check the installation according to Chapter 4.
- Return to operation according to Section 5.2.

6

Care and Maintenance

6.1 Care

- Occasionally the o-ring at the syringe adaptor **12** should be lubricated with the enclosed silicone grease. This will prolong the life.



Clean hands after application of grease to assure surfaces to be bonded are clean. Otherwise a fusion might fail.

- Clean adhesive residue from the pencil holder **18** or replace it with a new one as required.



If cleaning agents are not properly handled, damage to health can result!

- **Observe general safety regulations for the handling of chemicals!**
- **Observe manufacturer's instructions! Request a safety data sheet for the product used!**

Recommended cleaning agents for:



- Anaerobic, UV curing, and Chipbonder® adhesives:
Loctite® brand cured adhesives cannot be removed with the solvents that are permitted to be used at the present time.
Fluid adhesive residues can be removed with various solvents.
ACETONE is well suited for this application.
- Cyanoacrylate adhesives:
The best solvent is ACETONE.

Supply sources for solvents:

- ACETONE Local specialist dealers

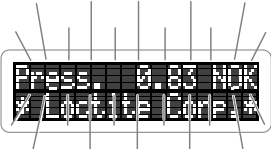

6.2 Maintenance

The unit requires no special maintenance.

Type of malfunction	Possible causes	Correction
The digital display does not light.	<ul style="list-style-type: none"> – No power voltage present. – Power switch 10 in position O (OFF). – Power fuse 23 is defective. – Power cord 19 is defective. – Control unit is defective. 	<ul style="list-style-type: none"> ● Check the power voltage. ● Switch power switch 10 to position I (ON). ● Check/replace fuse 23. ● Replace power cord 19. ● Contact Henkel Service.
No change in the value on the digital display.	<ul style="list-style-type: none"> – No air pressure is present. – Control unit is defective. 	<ul style="list-style-type: none"> ● Check pneumatic supply. ● Contact Henkel Service.
No product, too little or too much product.	<ul style="list-style-type: none"> – Dispensing pressure is not set correctly. – Pressure hose is not properly connected. – Syringe 15 is not properly connected. – Hose clamp 11 is pressed closed. – Luer-Lock tip cap 17 is not removed. – Dispensing needle 16 is clogged, too small or too large. – Control unit is defective. 	<ul style="list-style-type: none"> ● Adjust dispensing pressure setting. ● Connect air pressure hose correctly. ● Attach syringe 15 correctly (Section 5.2.1). ● Release hose clamp 11. ● Replace Luer-Lock tip cap 17 with a dispensing needle 16. ● Replace dispensing needle 16. ● Contact Henkel Service.
<p>The error message (with beeping) blinks in the digital display:</p>  <p>Press. = Dispensing pressure. 0.83 [bar/psi] = Example for the indication of dispensing pressure. NOK = Not O.K.</p>	<ul style="list-style-type: none"> – The unit was switched off and the pressure regulator 9 is now adjusting to the dispensing pressure setting. The indicated dispensing pressure is increased continuously. – Pressure regulator 9 was unintentionally changed by more than $\pm 10\%$. – Dispensing pressure was set to a new value of more than $\pm 10\%$. – Leak in the system. 	<ul style="list-style-type: none"> ● Wait until the pressure regulator 9 has adjusted the dispensing pressure. The error message and beeping are eliminated when the indicated dispensing pressure is within -10% of the stored comparison value. ● Adjust pressure regulator 9 until the error message and beeping are eliminated. ● Press button  to store the indicated dispensing pressure as the new comparison value for the automatic pressure monitoring. This eliminates the error message and beeping. ● Check system for leakage. ● Contact Henkel Service.
Product drips.	<ul style="list-style-type: none"> – Vacuum regulator 7 is set too low. – Exhaust air silencer 22 is clogged. 	<ul style="list-style-type: none"> ● Turn the vacuum regulator 7 counter clockwise until the dripping stops (Section 5.2.1). ● Replace the silencer.

7

Troubleshooting

Type of malfunction	Possible causes	Correction
LED in button  or  does not light.	<ul style="list-style-type: none"> – LED is defective. – Button is defective. – Control unit is defective. 	<ul style="list-style-type: none"> ● Contact Henkel Service. When the button is operational (check by means of the digital display), the unit can be used until repaired by Henkel Service. ● Contact Henkel Service. ● Contact Henkel Service.
No start signal.	<ul style="list-style-type: none"> – Plug on the socket XS1: Start 25 is loose. – Foot Switch 20 is defect. – Control unit is defective. 	<ul style="list-style-type: none"> ● Switch the power switch 10 to the position O (OFF). Tighten the screws of the plug. Switch the power switch 10 to the position I (ON). ● Replace the Foot Switch 20. To test (alternative), use button . ● Contact Henkel Service.
No reaction from the buttons.	<ul style="list-style-type: none"> – Button is defective. 	<ul style="list-style-type: none"> ● Contact Henkel Service.

8

Documentation

8.1 Pin Connections for Foot Switch Cable

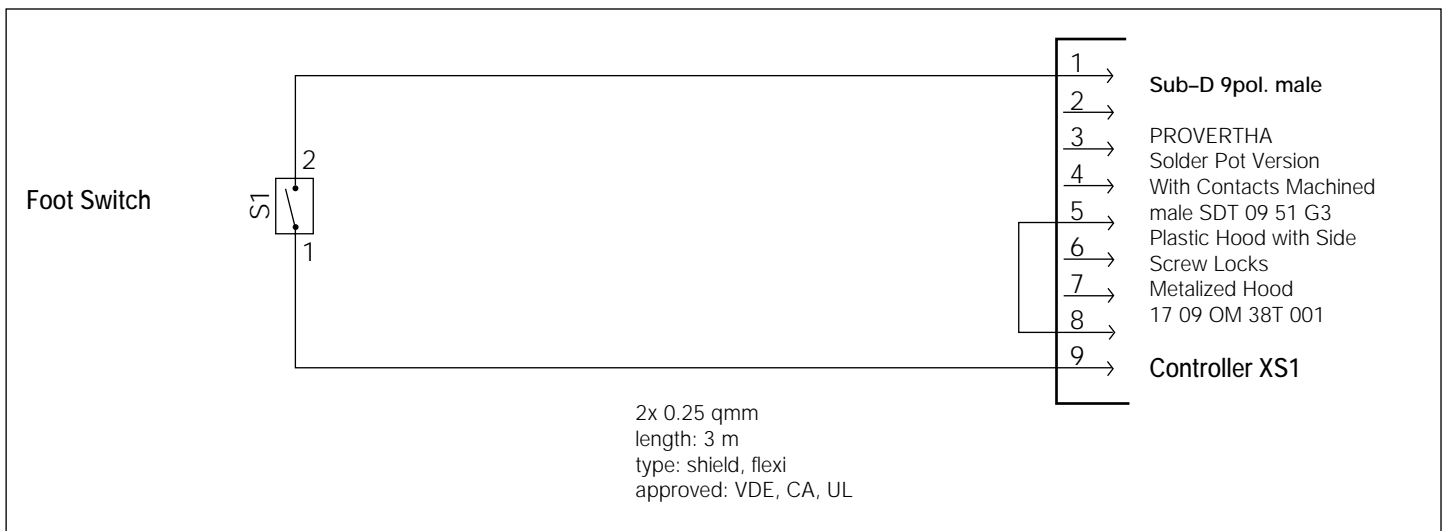

8

Documentation

8.2 Accessories and Spare Parts



- Reference out the illustration inside the rear cover!

Pos. No.	Description	Loctite Order No.
1	10 ml Air Line Adapters (2 pcs/box)	97208
	30 ml Air Line Adapters (2 pcs/box)	97245
2	10 ml Clear Syringe Package (30 pcs/box)	97207
	30 ml Clear Syringe Package (20 pcs/box)	97244
3	Dispense Needle, Polyethylene – Conical (PPC), especially for viscous products and large dispensing quantities:	
	Dispense Needle PPC16GA (50 pcs/box), ID Size 1,20 mm, black	98387
	Dispense Needle PPC18GA (50 pcs/box), ID Size 0,84 mm, green	98389
	Dispense Needle PPC20GA (50 pcs/box), ID Size 0,58 mm, pink	98391
	Dispense Needle PPC22GA (50 pcs/box), ID Size 0,41 mm, blue	98393
4	Dispense Needle, Stainless Steel – Standard (SSS), especially for low viscosity and UV curing products:	
	Dispense Needle SSS15GA (50 pcs/box), ID Size 1,37 mm, amber	98396
	Dispense Needle SSS18GA (50 pcs/box), ID Size 0,84 mm, green	98398
	Dispense Needle SSS20GA (50 pcs/box), ID Size 0,58 mm, pink	98400
	Dispense Needle SSS25GA (50 pcs/box), ID Size 0,25 mm, red	98404
5	Dispense Needle, Polypropylene – Flexible (PPF), especially for fast curing products:	
	Dispense Needle PPP15GA (50 pcs/box), ID Size 1,37 mm, amber	97229
	Dispense Needle PPP18GA (50 pcs/box), ID Size 0,84 mm, green	97230
	Dispense Needle PPP20GA (50 pcs/box), ID Size 0,58 mm, pink	97231
	Dispense Needle PPP25GA (50 pcs/box), ID Size 0,25 mm, red	97232
6	Pencil Holder	984625
7	Foot Switch	97201
8	Filter Regulator	985397

9.1 Declarations of Conformity

Declaration of Conformity	
In accordance with the EC Regulations for Electro-Magnetic Compatibility 89/336/EEC, Appendix I	
Manufacturer	Henkel Loctite Deutschland GmbH Arabellastraße 17 D-80925 München
declares that the unit designated in the following is, as a result of its design and construction, in accordance with the European regulations, harmonized standards, national standards and technical specifications listed below.	
Designation of the unit	Digital Syringe Dispenser
Unit number	97006
Applicable EC Regulations	EC Regulations for Electro-Magnetic Compatibility 89/336/EC in the version 93/68/EC
Applicable harmonized standards	EN 50082-1 1992; EN 55014 / 4.1993; IEC 801-2, 3, 4
Date / Manufacturer s signature	09/15/2000 / General Manager 
For changes to the unit that were not approved by Henkel, this declaration loses its validity.	

Declaration of Conformity	
In accordance with the EC Machine Regulations 98/37/EC	
Manufacturer	Henkel Loctite Deutschland GmbH Arabellastraße 17 D-80925 München
declares that the unit designated in the following is, as a result of its design and construction, in accordance with the European regulations, harmonized standards, national standards and technical specifications listed below.	
Designation of the unit	Digital Syringe Dispenser
Unit number	97006
Applicable EC Regulations	EC-Machine Regulations 98/37/EC
Applicable harmonized standards	DIN EN 292 Part 1 11.1991; DIN EN 292 Part 2 11.1991
Date / Manufacturer s signature	09/15/2000 / General Manager 
For changes to the unit that were not approved by Henkel, this declaration loses its validity.	

9

Declarations of Conformity

9.2 Warranty

WARRANTY

Henkel expressly warrants that all products referred to in this Instruction Manual for (97006 Henkel Digital Syringe Dispenser) (hereafter called "Products") shall be free from defects in materials and workmanship. Liability for Henkel shall be limited, as its option, to replacing those Products which are shown to be defective in either materials or workmanship or to credit the purchaser the amount of the purchase price thereof (plus freight and insurance charges paid therefor by the user). The purchaser's sole and exclusive remedy for breach of warranty shall be such replacement or credit.

A claim of defect in materials or workmanship in any Products shall be allowed only when it is submitted in writing within one month after discovery of the defect or after the time the defect should reasonably have been discovered and in any event, within (12) months after the delivery of the Products to the purchaser. This warranty does not apply to perishable items, such as (indicate items: fuses, filters, lights, etc.). No such claim shall be allowed in respect of products which have been neglected or improperly stored, transported, handled, installed, connected, operated, used or maintained. In the event of unauthorized modification of the Products including, where products, parts or attachments for use in connection with the Products are available from Henkel, the use of products, parts or attachments which are not manufactured by Henkel, no claim shall be allowed.

No Products shall be returned to Henkel for any reason without prior written approval from Henkel. Products shall be returned freight prepaid, in accordance with instructions from Henkel.

NO WARRANTY IS EXTENDED TO ANY EQUIPMENT WHICH HAS BEEN ALTERED, MISUSED, NEGLECTED, OR DAMAGED BY ACCIDENT, OR IF THE SYSTEM WAS USED TO DISPENSE ANY LIQUID MATERIAL OTHER THAN HENKEL PRODUCTS.

EXCEPT FOR THE EXPRESS WARRANTY CONTAINED IN THIS SECTION, HENKEL MAKES NO WARRANTY OF ANY KIND WHATSOEVER, EXPRESS OR IMPLIED, WITH RESPECT TO THE PRODUCTS.

ALL WARRANTIES OF MERCHANTABILITY, FITNESS FOR A PARTICULAR PURPOSE, AND OTHER WARRANTIES OF WHATEVER KIND (INCLUDING AGAINST PATENT OR TRADEMARK INFRINGEMENT) ARE HEREBY DISCLAIMED BY HENKEL AND WAIVED BY THE PURCHASER.

THIS SECTION SETS FORTH EXCLUSIVELY ALL OF LIABILITY FOR HENKEL TO THE PURCHASER IN CONTRACT, IN TORT OR OTHERWISE IN THE EVENT OF DEFECTIVE PRODUCTS.

WITHOUT LIMITATION OF THE FOREGOING, TO THE FULLEST EXTENT POSSIBLE UNDER APPLICABLE LAWS, HENKEL EXPRESSLY DISCLAIMS ANY LIABILITY WHATSOEVER FOR ANY DAMAGES INCURRED DIRECTLY OR INDIRECTLY IN CONNECTION WITH THE SALE OR USE OF, OR OTHERWISE IN CONNECTION WITH, THE PRODUCTS, INCLUDING, WITHOUT LIMITATION, LOSS OF PROFITS AND SPECIAL, INDIRECT OR CONSEQUENTIAL DAMAGES, WHETHER CAUSED BY NEGLIGENCE FROM HENKEL OR OTHERWISE.

9.3 Service Representative

Contact Your local Henkel Representative.

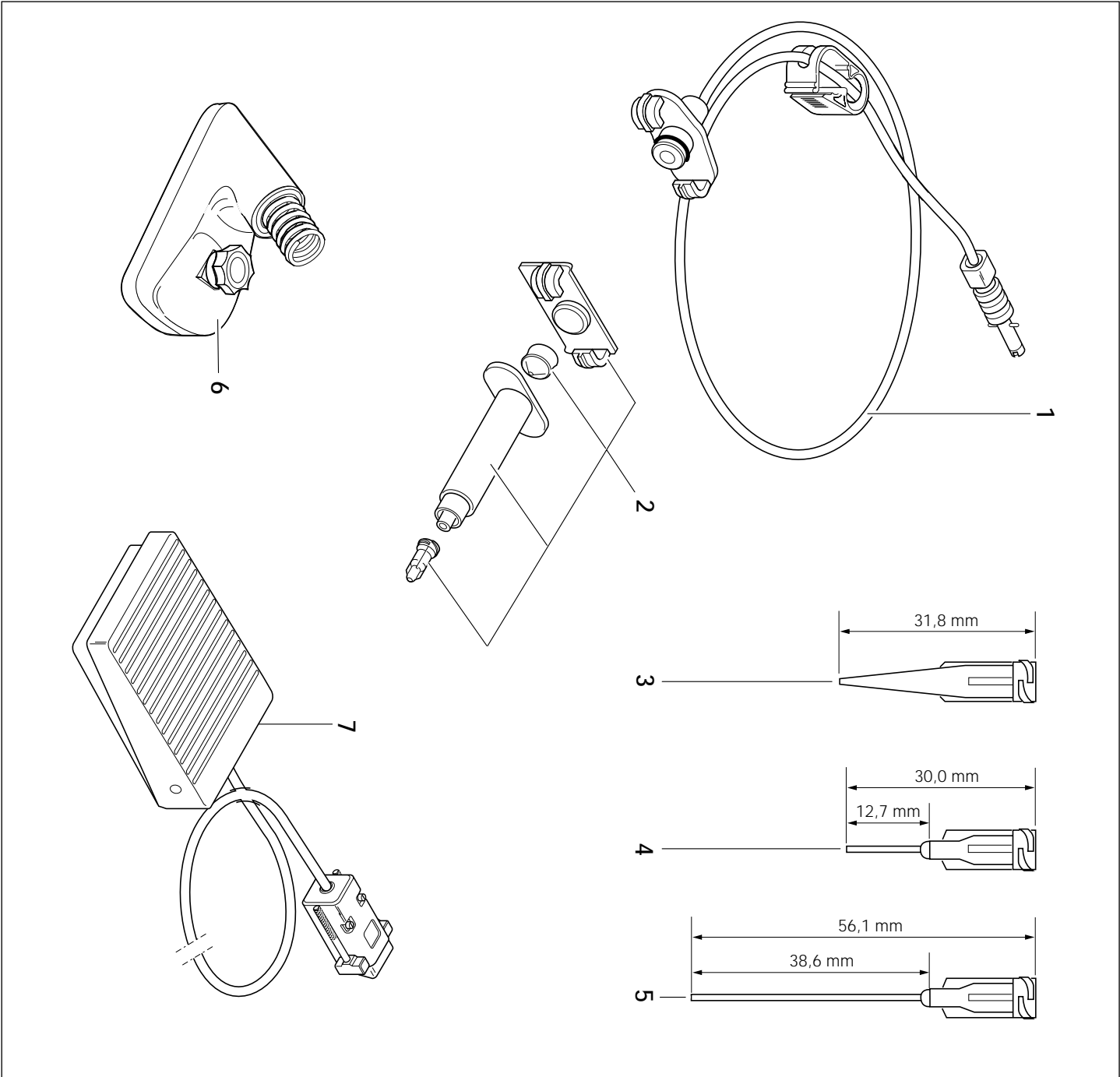

Loctite Industrial

Henkel Corporation

1001 Trout Brook Crossing
Rocky Hill, CT 06067-3910

Henkel Automotive Technology Center

2455 Featherstone Road
Auburn Hills, Michigan 48326

Henkel Canada Corporation

2225 Meadowpine Boulevard
Mississauga, Ontario L5N 7P2

Henkel Ltda. Brazil

Av. Prof. Vernon Kriebel, 91
06690-11-Itapevi
São Paulo-Brazil

Henkel Capital, S.A. de C.V.

Calz. de la Viga s/n Fracc. Los Laureles
Loc. Tulpetlac, Ecatepec, Edo. de México
RFC: HCA000314-IC0

www.loctite.com

Loctite and Chipbonder are registered trademarks of Henkel Corporation, U.S.A.

© Copyright 2004. Henkel Corporation. All rights reserved. Data in this operation manual is subject to change without notice.

Order Code No. 8950106USA Edition 01/2004